

2. MAINTENANCE DATA

(1) Cautions

- (a) If you are disassembling and checking an air-conditioner, be sure to turn off the power before beginning. When working on indoor units, let the unit sit for about 1 minute after turning off the power before you begin work. When working on an outdoor unit, there may be an electrical charge applied to the main circuit (electrolytic condenser), so begin work only after discharging this electrical charge (to DC10V or lower).
- (b) When taking out printed circuit boards, be sure to do so without exerting force on the circuit boards or package components.
- (c) When disconnecting and connecting connectors, take hold of the connector housing and do not pull on the lead wires.

(2) Items to check before troubleshooting

- (a) Have you thoroughly investigated the details of the trouble which the customer is complaining about?
- (b) Is the air-conditioner running? Is it displaying any self-diagnosis information?
- (c) Is a power source with the correct voltage connected?
- (d) Are the control lines connecting the indoor and outdoor units wired correctly and connected securely?
- (e) Is the outdoor unit's service valve open?

(3) Troubleshooting procedure (If the air-conditioner does not run at all)

If the air-conditioner does not run at all, diagnose the trouble using the following troubleshooting procedure. If the air-conditioner is running but breaks down, proceed to troubleshooting step (4).

Important When all the following conditions are satisfied, we say that the air-conditioner will not run at all.

- (a) The RUN light does not light up.
- (b) The flaps do not open.
- (c) The indoor unit fan motors do not run.
- (d) The self-diagnosis display does not function.

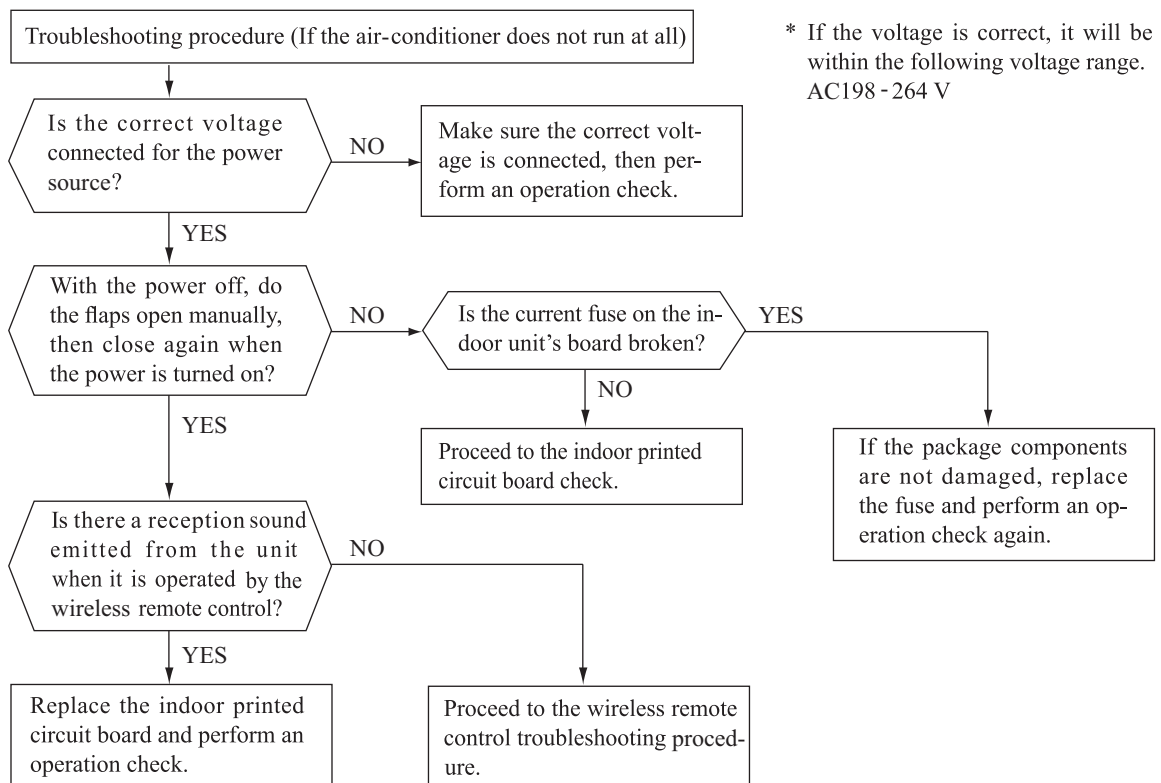

(4) Troubleshooting procedure (If the air-conditioner runs)

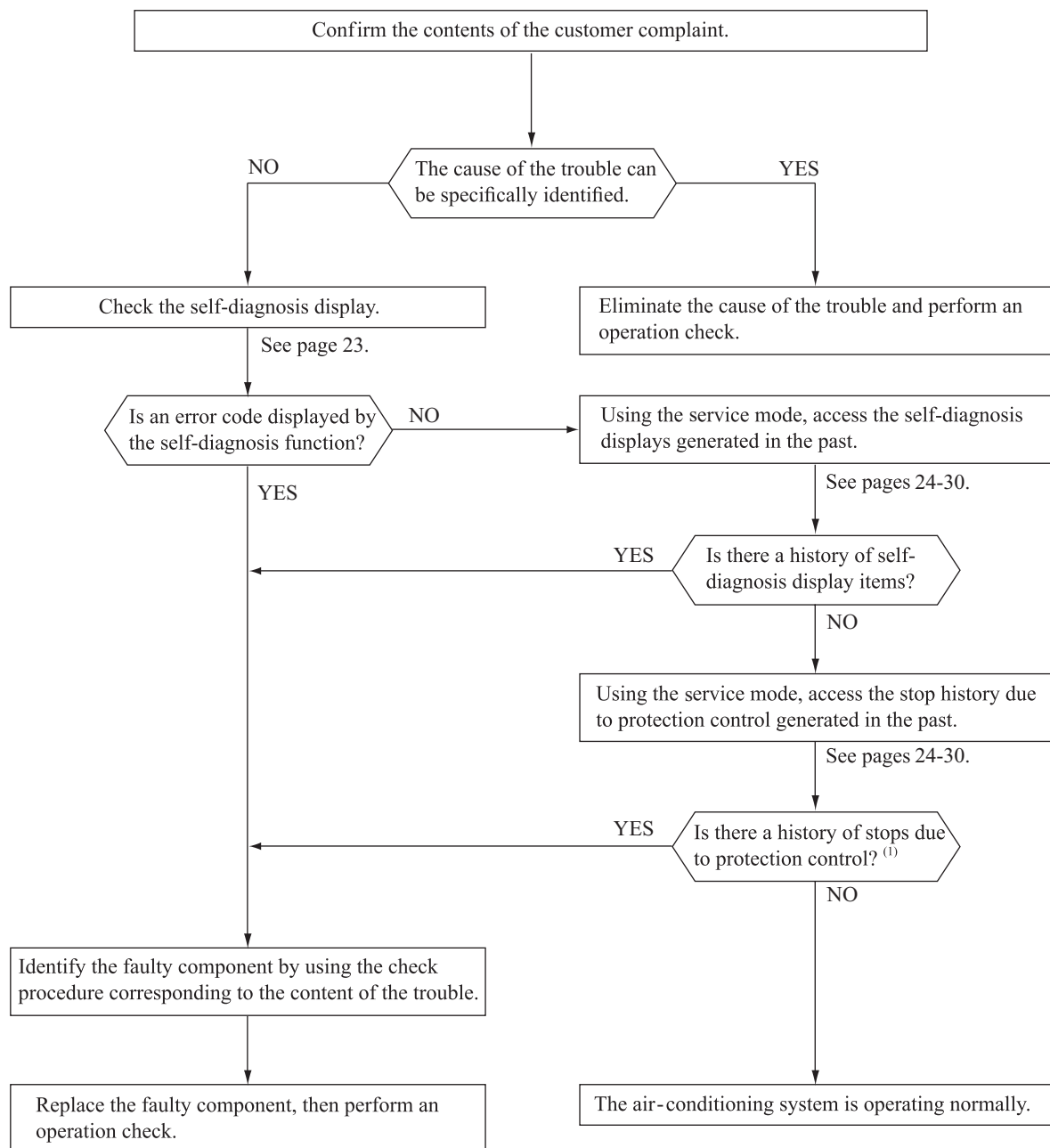

Note (1) Even in cases where only intermittent stop data are generated, the air-conditioning system is normal. However, if the same protective operation recurs repeatedly (3 or more times), it will lead to customer complaints. Judge the conditions in comparison with the contents of the complaints.

(5) Self-diagnosis table

When this air-conditioner performs an emergency stop, the reason why the emergency stop occurred is displayed by the flashing of display lights. If the air-conditioner is operated using the remote control 3 minutes or more after the emergency stop, the trouble display stops and the air-conditioner resumes operation. ⁽¹⁾

Indoor unit display panel		Wired ⁽²⁾ remote control display	Description of trouble	Cause	Display (flashing) condition
RUN light	TIMER light				
1-time flash	ON	—	Heat exchanger temperature sensor 1 error	<ul style="list-style-type: none"> Broken heat exchanger temperature sensor 1 wire, poor connector connection Indoor unit PCB is faulty 	When a heat exchanger temperature sensor 1 wire disconnection is detected while operation is stopped. (If a temperature of -28°C or lower is detected for 15 seconds, it is judged that the wire is disconnected.) (Not displayed during operation.)
2-time flash	ON	—	Room air temperature sensor error	<ul style="list-style-type: none"> Broken room temperature sensor wire, poor connector connection Indoor unit PCB is faulty 	When a room temperature sensor wire disconnection is detected while operation is stopped. (If a temperature of -45°C or lower is detected for 15 seconds, it is judged that the wire is disconnected.) (Not displayed during operation.)
3-time flash	ON	—	Heat exchanger temperature sensor 2 error	<ul style="list-style-type: none"> Broken heat exchanger temperature sensor 2 wire, poor connector connection Indoor unit PCB is faulty 	When a heat exchanger temperature sensor 2 wire disconnection is detected while operation is stopped. (If a temperature of -28°C or lower is detected for 15 seconds, it is judged that the wire is disconnected.) (Not displayed during operation.)
6-time flash	ON	E 16	Indoor fan motor error	<ul style="list-style-type: none"> Defective fan motor, poor connector connection 	When conditions for turning the indoor fan motor on exist during air-conditioner operation, an indoor fan motor speed of 300min ⁻¹ or lower is measured for 30 seconds or longer. (The air-conditioner stops.)
Keeps flashing	1-time flash	E 38	Outdoor air temperature sensor error	<ul style="list-style-type: none"> Broken outdoor air temperature sensor wire, poor connector connection Outdoor unit PCB is faulty 	-55°C or lower is detected for 5 seconds continuously 3 times within 40 minutes after initial detection of this anomalous temperature. Or -55°C or higher is detected for within 20 seconds after power ON. (The compressor is stopped.)
Keeps flashing	2-time flash	E 37	Outdoor heat exchanger temperature sensor error	<ul style="list-style-type: none"> Broken heat exchanger temperature sensor wire, poor connector connection Outdoor unit PCB is faulty 	-55°C or lower is detected for 5 seconds continuously 3 times within 40 minutes after initial detection of this anomalous temperature. Or -55°C or higher is detected for within 20 seconds after power ON. (The compressor is stopped.)
Keeps flashing	4-time flash	E 39	Discharge pipe temperature sensor error	<ul style="list-style-type: none"> Broken discharge pipe temperature sensor wire, poor connector connection Outdoor unit PCB is faulty 	-25°C or lower is detected for 5 seconds continuously 3 times within 40 minutes after initial detection of this anomalous temperature. (The compressor is stopped.)
ON	1-time flash	E 42	Current cut	<ul style="list-style-type: none"> Compressor locking, open phase on compressor output, short-circuit on power transistor, service valve is closed 	The compressor output current exceeds the set value during compressor start. (The air-conditioner stops.)
ON	2-time flash	E 59	Trouble of outdoor unit	<ul style="list-style-type: none"> Broken compressor wire Compressor blockage 	When there is an emergency stop caused by trouble in the outdoor unit, or the input current value is found to be lower than the set value. (The air-conditioner stops.)
ON	3-time flash	E 58	Current safe stop	<ul style="list-style-type: none"> Overload operation Overcharge Compressor locking 	When the compressor command speed is lower than the set value and the current safe has operated. (the compressor stops)
ON	4-time flash	E 51	Power transistor error	<ul style="list-style-type: none"> Broken power transistor 	When the power transistor is judged breakdown while compressor starts. (The compressor is stopped.)
ON	5-time flash	E 36	Over heat of compressor	<ul style="list-style-type: none"> Gas shortage, defective discharge pipe temperature sensor, service valve is closed 	When the value of the discharge pipe temperature sensor exceeds the set value. (The air-conditioner stops.)
ON	6-time flash	E 5	Error of signal transmission	<ul style="list-style-type: none"> Defective power source, Broken signal wire, defective indoor/outdoor unit PCB 	When there is no signal between the indoor unit PCB and outdoor unit PCB for 10 seconds or longer (when the power is turned on), or when there is no signal for 7 minute 35 seconds or longer (during operation) (the compressor is stopped).
ON	7-time flash	E 48	Outdoor fan motor error	<ul style="list-style-type: none"> Defective fan motor, poor connector connection 	When the outdoor fan motor speed continues for 30 seconds or longer at 75 min ⁻¹ or lower. (3 times) (The air-conditioner stops.)
ON	Keeps flashing	E 35	Cooling high pressure protecton	<ul style="list-style-type: none"> Overload operation, overcharge Broken outdoor heat exchanger temperature sensor wire Service valve is closed 	When the value of the outdoor heat exchanger temperature sensor exceeds the set value.
2-time flash	2-time flash	E 60	Rotor lock	<ul style="list-style-type: none"> Defective compressor Open phase on compressor Defective outdoor unit PCB 	If the compressor motor's magnetic pole positions cannot be correctly detected when the compressor starts. (The air-conditioner stops.)
4-time flash	ON	—	Trouble of wireless LAN interface	<ul style="list-style-type: none"> Defective wireless LAN interface boards, poor connector connection 	When normal data cannot be received from wireless LAN interface for two minutes continuously
5-time flash	ON	E 47	Active filter voltage error	<ul style="list-style-type: none"> Defective active filter 	When the wrong voltage connected for the power source. When the outdoor unit PCB is faulty
7-time flash	ON	E 57	Refrigeration cycle system protective control	<ul style="list-style-type: none"> Service valve is closed. Refrigerant is insufficient 	When refrigeration cycle system protective control operates.
7-time flash	1-time flash	E 40	Service valve (gas side) closed operation	<ul style="list-style-type: none"> Service valve (gas side) closed Defective outdoor unit PCB 	If the output current of inverter exceeds the specifications, it makes the compressor stopping. (In heating mode). After 3-minute delay, the compressor restarts, but if this anomaly occurs 2 times within 20 minutes after the initial detection.
—	—	E 1	Error of wired remote control wiring	<ul style="list-style-type: none"> Broken wired remote control wire, defective indoor unit PCB 	The wired remote control wire Y is open. The wired remote control wires X and Y are reversely connected. Noise is penetrating the wired remote control lines. The wired remote control or indoor unit PCB is faulty. (The communications circuit is faulty.)

Notes (1)The air-conditioner cannot be restarted using the remote control for 3 minutes after operation stops.

(2)The wired remote control is option parts.

(6) Service mode (Trouble mode access function)

This air-conditioner is capable of recording error displays and protective stops (service data) which have occurred in the past. If self-diagnosis displays cannot be confirmed, it is possible to get a grasp of the conditions at the time trouble occurred by checking these service data.

(a) Explanation of terms

Term	Explanation
Service mode	The service mode is the mode where service data are displayed by flashing of the display lights when the operations in item (b) below are performed with the indoor control.
Service data	These are the contents of error displays and protective stops which occurred in the past in the air-conditioner system. Error display contents and protective stop data from past anomalous operations of the air-conditioner system are saved in the indoor unit control's non-volatile memory (memory which is not erased when the power goes off). There are two types of data, self-diagnosis data and stop data, described below.
Self-diagnosis data	These are the data which display the reason why a stop occurred when an error display(self-diagnosis display) occurred in an indoor unit. Data are recorded for up to 5 previous occurrences. Data which are older than the 5th previous occurrence are erased. In addition, data on the temperature of each sensor (room temperature, indoor heat exchanger, outdoor heat exchanger, outdoor air temperature, discharge pipe), remote control information (operation switching, fan speed switching) are recorded when trouble occurs, so more detailed information can be checked.
Stop data	These are the data which display the reason by a stop occurred when the air-conditioning system performed protective stops, etc. in the past. Even if stop data alone are generated, the system restarts automatically. (After executing the stop mode while the display is normal, the system restarts automatically.) Data for up to 10 previous occasions are stored. Data older than the 10th previous occasion are erased. (Important) In cases where transient stop data only are generated, the air-conditioner system may still be normal. However, if the same protective stop occurs frequently (3 or more times), it could lead to customer complaints.

(b) Service mode display procedure

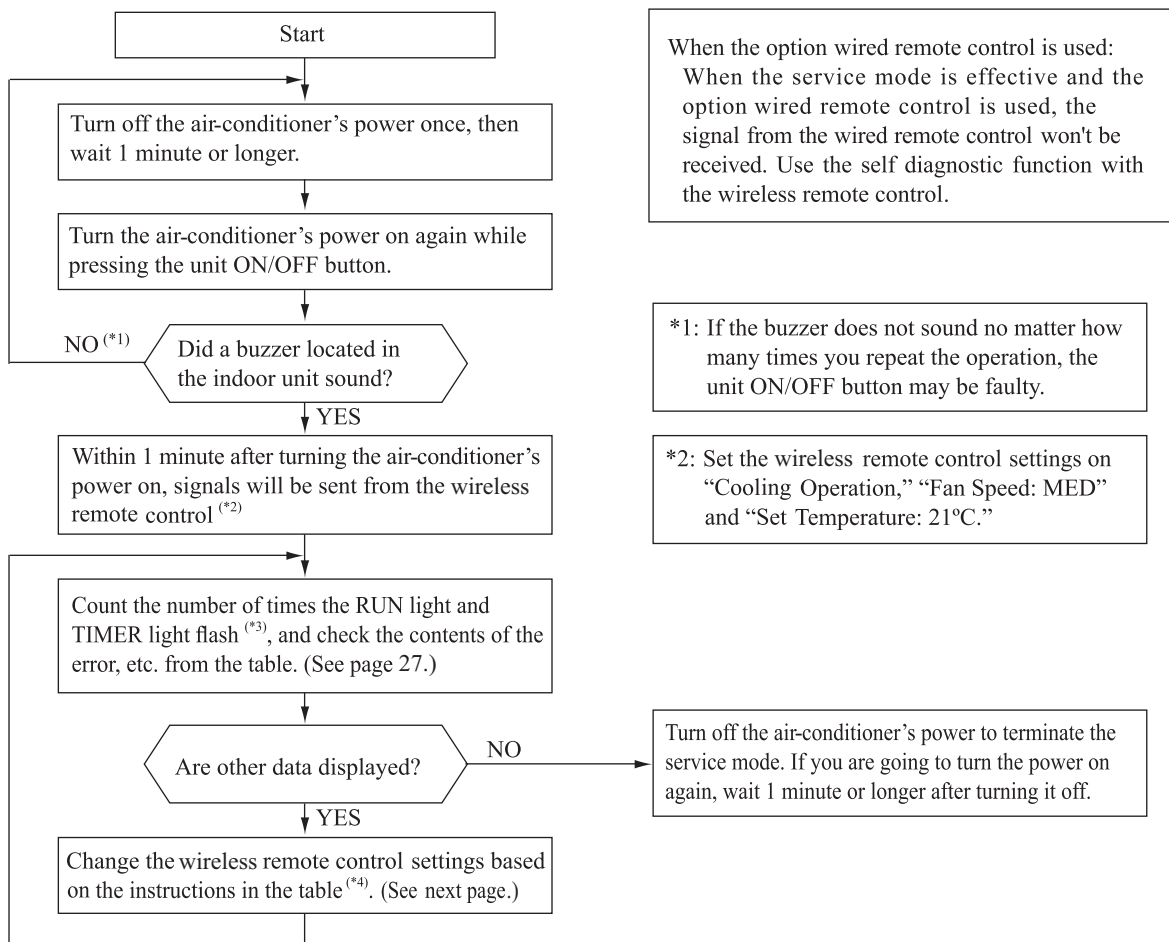

*3: To count the number of flashes in the service mode, count the number of flashes after the light lights up for 1.5 second initially (start signal). (The time that the light lights up for 1.5 second (start signal) is not counted in the number of flashes.)

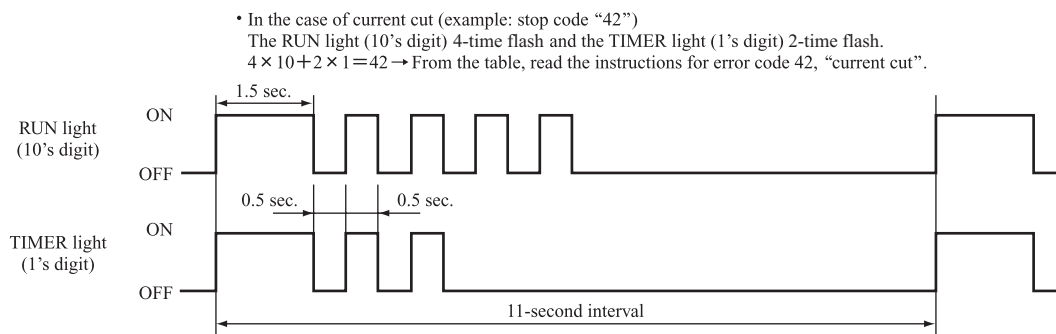

*4: When in the service mode, when the wireless remote control settings (operation mode, fan speed mode, temperature setting) are set as shown in the following table and sent to the air-conditioner unit, the unit switches to display of service data.

(i) Self-diagnosis data

What are Self-diagnosis Data?

These are control data (reasons for stops, temperature at each sensor, wireless remote control information) from the time when there were error displays (abnormal stops) in the indoor unit in the past. Data from up to 5 previous occasions are stored in memory. Data older than the 5th previous occasion are erased. The temperature setting indicates how many occasions previous to the present setting the error display data are and the operation mode and fan speed mode data show the type of data.

Wireless remote control setting		Contents of output data
Operation mode	Fan speed mode	
Cooling	MED	Displays the reason for stopping display in the past (error code).
	HI	Displays the room temperature sensor temperature at the time the error code was displayed in the past.
	AUTO	Displays the indoor heat exchanger temperature sensor temperature at the time the error code was displayed in the past.
Heating	LO	Displays the wireless remote control information at the time the error code was displayed in the past.
	MED	Displays the outdoor air temperature sensor temperature at the time the error code was displayed in the past.
	HI	Displays the outdoor heat exchanger temperature sensor temperature at the time the error code was displayed in the past.
	AUTO	Displays the discharge pipe temperature sensor temperature at the time the error code was displayed in the past.

Wireless remote control setting	Indicates the number of occasions previous to the present the error display data are from.
Temperature setting	
21°C	1 time previous (previous time)
22°C	2 times previous
23°C	3 times previous
24°C	4 times previous
25°C	5 times previous

Only for indoor heat exchanger temperature sensor 2

Wireless remote control setting	Indicates the number of occasions previous to the present the error display data are from.
Temperature setting	
26°C	1 time previous (previous time)
27°C	2 times previous
28°C	3 times previous
29°C	4 times previous
30°C	5 times previous

(Example)

Wireless remote control setting			Displayed data
Operation mode	Fan speed mode	Temperature setting	
Cooling	MED	21°C	Displays the reason for the stop (error code) the previous time an error was displayed.
		22°C	Displays the reason for the stop (error code) 2 times previous when an error was displayed.
		23°C	Displays the reason for the stop (error code) 3 times previous when an error was displayed.
		24°C	Displays the reason for the stop (error code) 4 times previous when an error was displayed.
		25°C	Displays the reason for the stop (error code) 5 times previous when an error was displayed.

(ii) Stop data

Wireless remote control setting			Displayed data
Operation mode	Fan speed mode	Temperature setting	
Cooling	LO	21°C	Displays the reason for the stop (stop code) the previous time when the air-conditioner was stopped by protective stop control.
		22°C	Displays the reason for the stop (stop code) 2 times previous when the air-conditioner was stopped by protective stop control.
		23°C	Displays the reason for the stop (stop code) 3 times previous when the air-conditioner was stopped by protective stop control.
		24°C	Displays the reason for the stop (stop code) 4 times previous when the air-conditioner was stopped by protective stop control.
		25°C	Displays the reason for the stop (stop code) 5 times previous when the air-conditioner was stopped by protective stop control.
		26°C	Displays the reason for the stop (stop code) 6 times previous when the air-conditioner was stopped by protective stop control.
		27°C	Displays the reason for the stop (stop code) 7 times previous when the air-conditioner was stopped by protective stop control.
		28°C	Displays the reason for the stop (stop code) 8 times previous when the air-conditioner was stopped by protective stop control.
		29°C	Displays the reason for the stop (stop code) 9 times previous when the air-conditioner was stopped by protective stop control.
		30°C	Displays the reason for the stop (stop code) 10 times previous when the air-conditioner was stopped by protective stop control.

(c) **Error code, stop code table** (Assignment of error codes and stop codes is done in common for all models.)

Number of flashes when in service mode		Stop code or Error code	Error content	Cause	Occurrence conditions	Error display	Auto recovery
RUN light (10's digit)	TIMER light (1's digit)						
OFF	OFF	0	Normal	—	—	—	—
	1-time flash	01	Error of wired remote control wiring (When wired remote control was connected) (When wireless LAN interface was connected, refer to page 23.)	Broken wired remote control wire defective indoor unit PCB.	The wired remote control wire Y is open. The wired remote control wires X and Y are reversely connected. Noise is penetrating the wired remote control lines. The wired remote control or indoor unit PCB is faulty.	—	○
	5-time flash	05	Can not receive signals for 35 seconds (if communications have recovered)	Power source is faulty Power source cables and signal lines are improperly wired. Indoor or outdoor unit PCB are faulty	When 35 seconds passes without communications signals from either the outdoor unit or the indoor unit being detected correctly.	○	—
3-time flash	5-time flash	35	Cooling high pressure control	Cooling overload operation. Outdoor unit fan speed drops. Outdoor heat exchanger temperature sensor is short-circuit.	When the outdoor heat exchanger temperature sensor's value exceeds the set value.	○ (5 times)	○
	6-time flash	36	Compressor overheat 110°C	Refrigerant is insufficient. Discharge pipe temperature sensor is faulty. Service valve is closed.	When the discharge pipe temperature sensor's value exceeds the set value.	○ (2 times)	○
	7-time flash	37	Outdoor heat exchanger temperature sensor is abnormal	Outdoor heat exchanger temperature sensor wire is disconnected. Connector connections are poor. Outdoor unit PCB is faulty	-55°C or lower is detected for 5 seconds continuously 3 times within 40 minutes after initial detection of this anomalous temperature. Or -55°C higher is detected for 5 seconds continuously within 20 seconds after power ON.	○ (3 times)	○
	8-time flash	38	Outdoor air temperature sensor is abnormal	Outdoor air temperature sensor wire is disconnected. Connector connections are poor. Outdoor unit PCB is faulty	-55°C or lower is detected for 5 seconds continuously 3 times within 40 minutes after initial detection of this anomalous temperature. Or -55°C higher is detected for 5 seconds continuously within 20 seconds after power ON.	○ (3 times)	○
	9-time flash	39	Discharge pipe temperature sensor is abnormal (anomalous stop)	Discharge pipe temperature sensor wire is disconnected. Connector connections are poor. Outdoor unit PCB is faulty	-25°C or lower is detected for 5 seconds continuously 3 times within 40 minutes after initial detection of this anomalous temperature.	○ (3 times)	○
4-time flash	OFF	40	Service valve (gas side) closed operation	Service valve (gas side) closed Outdoor unit PCB is faulty.	If the inverter output current value exceeds the setting value within 80 seconds after the compressor ON in the heating mode, the compressor stops.	○ (2 times)	○
	2-time flash	42	Current cut	Compressor lock. Compressor wiring short circuit. Compressor output is open phase. Outdoor unit PCB is faulty Service valve is closed. Electronic expansion valve is faulty. Compressor is faulty.	Compressor start fails 42 times in succession and the reason for the final failure is current cut.	○ (2 times)	○
	7-time flash	47	Active filter voltage error	Defective active filter	When the wrong voltage connected for the power source. When the outdoor unit PCB is faulty.	○	—
	8-time flash	48	Outdoor fan motor is abnormal	Outdoor fan motor is faulty. Connector connections are poor. Outdoor unit PCB is faulty	When a fan speed of 75 min ⁻¹ or lower continues for 30 seconds or longer.	○ (3 times)	○
5-time flash	1-time flash	51	Short-circuit in the power transistor (high side) Current cut circuit breakdown	Outdoor unit PCB is faulty Power transistor is damaged.	When it is judged that the power transistor was damaged at the time the compressor started.	○	—
	7-time flash	57	Refrigeration cycle system protective control	Service valve is closed. Refrigerant is insufficient.	When refrigeration cycle system protective control operates.	○ (3 times)	○
	8-time flash	58	Current safe	Refrigerant is overcharge. Compressor lock. Overload operation.	When there is a current safe stop during operation.	—	○
	9-time flash	59	Compressor wiring is unconnection Voltage drop Low speed protective control	Compressor wiring is disconnected. Power transistor is damaged. Power source construction is defective. Outdoor unit PCB is faulty Compressor is faulty.	When the current is 1A or less at the time the compressor started. When the power source voltage drops during operation. When the compressor command speed is lower than 32 rps for 60 minutes.	○	○
6-time flash	OFF	60	Rotor lock	Compressor is faulty. Compressor output is open phase. Electronic expansion valve is faulty. Overload operation. Outdoor unit PCB is faulty	After the compressor starts, when the compressor stops due to rotor lock.	○ (2 times)	○
	1-time flash	61	Connection lines between the indoor and outdoor units are faulty	Connection lines are faulty. Indoor or outdoor unit PCB are faulty	When 10 seconds passes after the power is turned on without communications signals from the indoor or outdoor unit being detected correctly.	○	—
	2-time flash	62	Serial transmission error	Indoor or outdoor unit PCB are faulty Noise is causing faulty operation.	When 7 minute 35 seconds passes without communications signals from either the outdoor unit or the indoor unit being detected correctly.	○	—
8-time flash	OFF	80	Indoor fan motor is abnormal	Indoor fan motor is faulty. Connector connections are poor. Indoor unit PCB is faulty	When the indoor fan motor is detected to be running at 300min ⁻¹ or lower speed with the fan motor in the ON condition while the air-conditioner is running.	○	—
	2-time flash	82	Indoor heat exchanger temperature sensor is abnormal (anomalous stop)	Indoor heat exchanger temperature sensor wire is disconnected. Connector connections are poor.	When a temperature of -28°C or lower is sensed continuously for 40 minutes during heating operation. (the compressor stops).	○	—
	4-time flash	84	Anti-condensation control	High humidity condition.	Anti-condensation prevention control is operating.	—	○
	5-time flash	85	Anti-frost control	Indoor fan speed drops. Indoor heat exchanger temperature sensor is broken wire.	When the anti-frost control operates and the compressor stops during cooling operation.	—	○
	6-time flash	86	Heating high pressure control	Heating overload operation. Indoor fan speed drops. Indoor heat exchanger temperature sensor is short-circuit.	When high pressure control operates during heating operation and the compressor stops.	—	○

Notes (1) The number of flashes when in the service mode do not include the 1.5 second period when the lights light up at first (start signal).
(See the example shown below.)

- In the case of current cut (example: stop code “42”)
 - The RUN light (10’s digit) 4-time flash and the TIMER light (1’s digit) 2-time flash.
 - $4 \times 10 + 2 \times 1 = 42 \rightarrow$ From the table, read the instructions for error code 42, “current cut”.

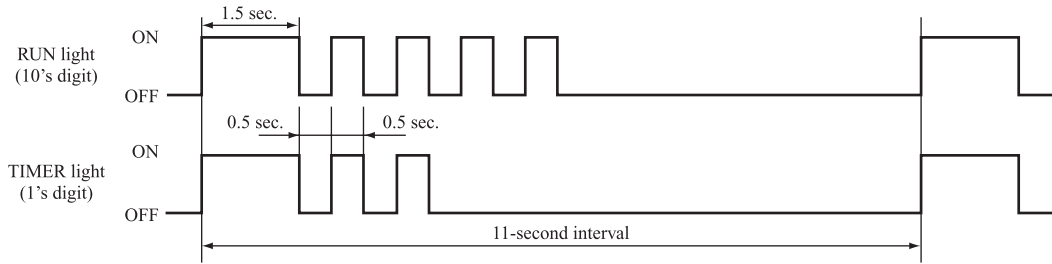

- (2) Error display: — Is not displayed. (automatic recovery only)
 ○ Displayed.
 If there is a () displayed, the error display shows the number of times that an auto recovery occurred for the same reason has reached the number of times in ().
 If no () is displayed, the error display shows that the trouble has occurred once.
- (3) Auto Recovery: — Does not occur
 ○ Auto recovery occurs.

(d) Operation mode, Fan speed mode information tables

(i) Operation mode

Display pattern when in service mode	Operation mode when there is an abnormal stop
RUN light (10's digit)	
—	AUTO
1-time flash	DRY
2-time flash	COOL
3-time flash	FAN
4-time flash	HEAT

(ii) Fan speed mode

Display pattern when in service mode	Fan speed mode when there is an abnormal stop
TIMER light (1's digit)	
—	AUTO
2-time flash	HI
3-time flash	MED
4-time flash	LO
5-time flash	ULO
6-time flash	HI POWER
7-time flash	ECONO

* If no data are recorded (error code is normal), the information display in the operation mode and fan speed mode becomes as follows.

Mode	Display when error code is normal
Operation mode	AUTO
Fan speed mode	AUTO

(Example): Operation mode: COOL, Fan speed mode: HI

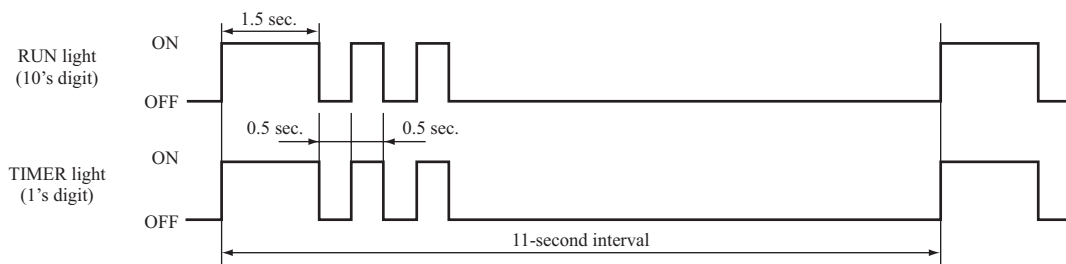

(e) Temperature information

(i) Room temperature sensor, indoor heat exchanger temperature sensor, outdoor air temperature sensor, outdoor heat exchanger temperature sensor

Unit: °C

Buzzer sound	TIMER light (1's digit)	RUN light (10's digit)										
		0	1	2	3	4	5	6	7	8	9	
Yes (sounds for 0.1 second)	6	-60	-61	-62	-63	-64						
	5	-50	-51	-52	-53	-54	-55	-56	-57	-58	-59	
	4	-40	-41	-42	-43	-44	-45	-46	-47	-48	-49	
	3	-30	-31	-32	-33	-34	-35	-36	-37	-38	-39	
	2	-20	-21	-22	-23	-24	-25	-26	-27	-28	-29	
	1	-10	-11	-12	-13	-14	-15	-16	-17	-18	-19	
	0	/	-1	-2	-3	-4	-5	-6	-7	-8	-9	
No (does not sound)	0	0	1	2	3	4	5	6	7	8	9	
	1	10	11	12	13	14	15	16	17	18	19	
	2	20	21	22	23	24	25	26	27	28	29	
	3	30	31	32	33	34	35	36	37	38	39	
	4	40	41	42	43	44	45	46	47	48	49	
	5	50	51	52	53	54	55	56	57	58	59	
	6	60	61	62	63	64	65	66	67	68	69	
	7	70	71	72	73	74	75	76	77	78	79	
	8	80	81	82	83	84	85	86	87	88	89	
	9	90	91	92	93	94	95	96	97	98	99	

* If no data are recorded (error code is normal), the display for each temperature information becomes as shown below.

Sensor name	Sensor value displayed when the error code is normal
Room temperature sensor	-64°C
Indoor heat exchanger temperature sensor	-64°C
Outdoor air temperature sensor	-64°C
Outdoor heat exchanger temperature sensor	-64°C

(Example) Outdoor heat exchanger temperature data: “-9°C”

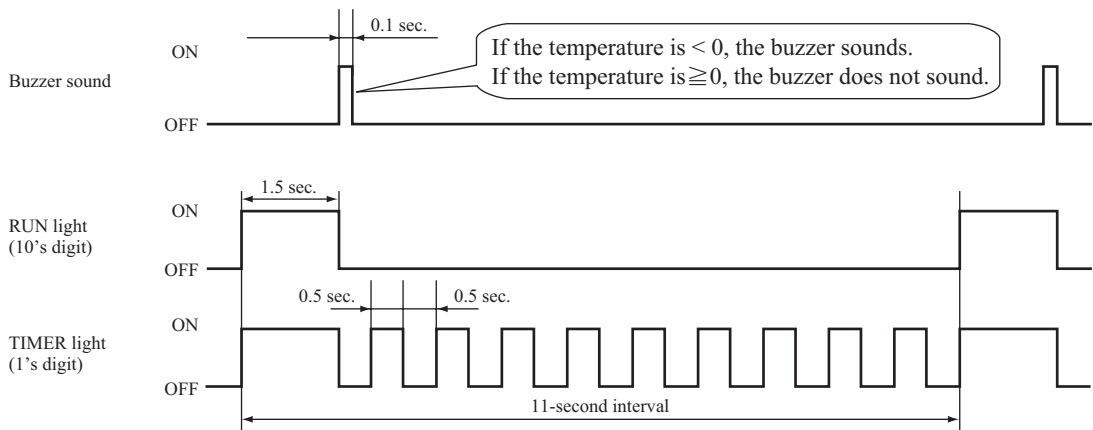

(ii) Discharge pipe temperature sensor

		Unit: °C									
		TIMER light (1's digit)			RUN light (10's digit)						
Buzzer sound		0	1	2	3	4	5	6	7	8	9
Yes (sounds for 0.1 second)	3	-60	-62	-64							
	2	-40	-42	-44	-46	-48	-50	-52	-54	-56	-58
	1	-20	-22	-24	-26	-28	-30	-32	-34	-36	-38
	0	/	-2	-4	-6	-8	-10	-12	-14	-16	-18
No (does not sound)	0	0	2	4	6	8	10	12	14	16	18
	1	20	22	24	26	28	30	32	34	36	38
	2	40	42	44	46	48	50	52	54	56	58
	3	60	62	64	66	68	70	72	74	76	78
	4	80	82	84	86	88	90	92	94	96	98
	5	100	102	104	106	108	110	112	114	116	118
	6	120	122	124	126	128	130	132	134	136	138
	7	140	142	144	146	148	150				

* If no data are recorded (error code is normal), the display for each temperature information becomes as shown below.

Sensor name	Sensor value displayed when the error code is normal
Discharge pipe temperature sensor	-64°C

(Example) Discharge pipe temperature data: "122°C"

* In the case of discharge pipe data, multiply the reading value by 2. (Below, $61 \times 2 = "122°C"$)

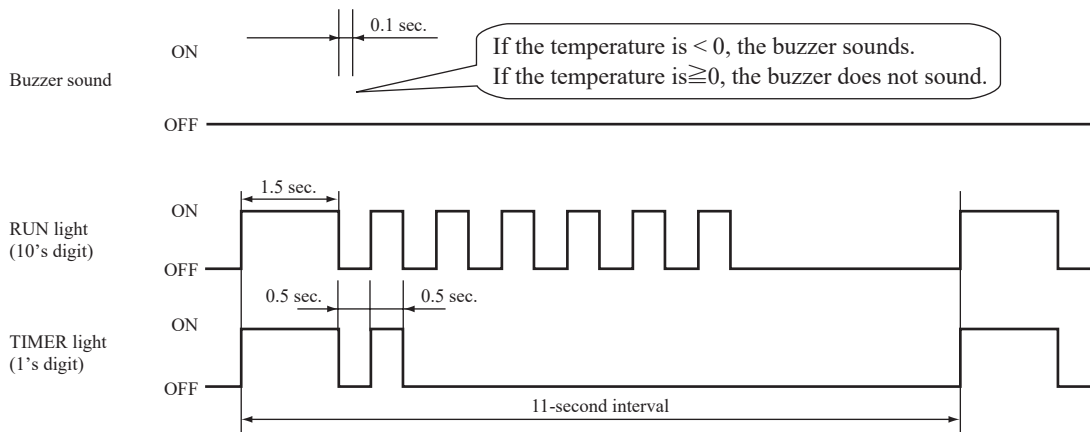

Service data record form

Customer				Model			
Date of investigation							
Machine name							
Content of complaint							
Wireless remote control settings			Content of displayed data	Display results			Display content
Temperature setting	Operation mode	Fan speed mode		Buzzer (Yes/No.)	RUN light (Times)	TIMER light (Times)	
21	Cooling	MED	Error code on previous occasion	/			
		HI	Room temperature sensor on previous occasion				
		AUTO	Indoor heat exchanger temperature sensor 1 on previous occasion				
	Heating	LO	Wireless remote control information on previous occasion	/			
		MED	Outdoor air temperature sensor on previous occasion				
		HI	Outdoor heat exchanger temperature sensor on previous occasion				
	AUTO	Discharge pipe temperature sensor on previous occasion					
26	Cooling	AUTO	Indoor heat exchanger temperature sensor 2 on previous occasion				
22	Cooling	MED	Error code on second previous occasion	/			
		HI	Room temperature sensor on second previous occasion				
		AUTO	Indoor heat exchanger temperature sensor 1 on second previous occasion				
	Heating	LO	Wireless remote control information on second previous occasion	/			
		MED	Outdoor air temperature sensor on second previous occasion				
		HI	Outdoor heat exchanger temperature sensor on second previous occasion				
	AUTO	Discharge pipe temperature sensor on second previous occasion					
27	Cooling	AUTO	Indoor heat exchanger temperature sensor 2 on second occasion				
23	Cooling	MED	Error code on third previous occasion	/			
		HI	Room temperature sensor on third previous occasion				
		AUTO	Indoor heat exchanger temperature sensor 1 on third previous occasion				
	Heating	LO	Wireless remote control information on third previous occasion	/			
		MED	Outdoor air temperature sensor on third previous occasion				
		HI	Outdoor heat exchanger temperature sensor on third previous occasion				
	AUTO	Discharge pipe temperature sensor on third previous occasion					
28	Cooling	AUTO	Indoor heat exchanger temperature sensor 2 on third occasion				
24	Cooling	MED	Error code on fourth previous occasion	/			
		HI	Room temperature sensor on fourth previous occasion				
		AUTO	Indoor heat exchanger temperature sensor 1 on fourth previous occasion				
	Heating	LO	Wireless remote control information on fourth previous occasion	/			
		MED	Outdoor air temperature sensor on fourth previous occasion				
		HI	Outdoor heat exchanger temperature sensor on fourth previous occasion				
	AUTO	Discharge pipe temperature sensor on fourth previous occasion					
29	Cooling	AUTO	Indoor heat exchanger temperature sensor 2 on fourth occasion				
25	Cooling	MED	Error code on fifth previous occasion	/			
		HI	Room temperature sensor on fifth previous occasion				
		AUTO	Indoor heat exchanger temperature sensor 1 on fifth previous occasion				
	Heating	LO	Wireless remote control information on fifth previous occasion	/			
		MED	Outdoor air temperature sensor on fifth previous occasion				
		HI	Outdoor heat exchanger temperature sensor on fifth previous occasion				
	AUTO	Discharge pipe temperature sensor on fifth previous occasion					
30	Cooling	AUTO	Indoor heat exchanger temperature sensor 2 on fifth occasion				
21	Cooling	LO	Stop code on previous occasion				
22			Stop code on second previous occasion				
23			Stop code on third previous occasion				
24			Stop code on fourth previous occasion				
25			Stop code on fifth previous occasion				
26			Stop code on sixth previous occasion				
27			Stop code on seventh previous occasion				
28			Stop code on eighth previous occasion				
29			Stop code on ninth previous occasion				
30			Stop code on tenth previous occasion				
Judgment							Examiner
Remarks							

Note (1) In the case of indoor heat exchanger temperature sensor 2, match from 26 to 30 the temperature setting of wireless remote control. (Refer to page 25.)

(7) Inspection procedures corresponding to detail of trouble

Sensor error

[Broken sensor wire, connector poor connection]

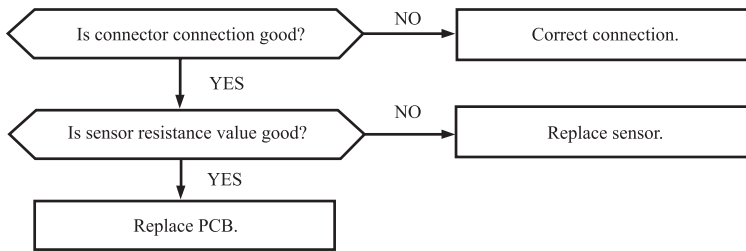

◆ Discharge pipe temperature sensor characteristics

◆ Temperature sensor characteristics (Room air temperature, indoor heat exchanger temperature, outdoor heat exchanger temperature, outdoor air temperature)

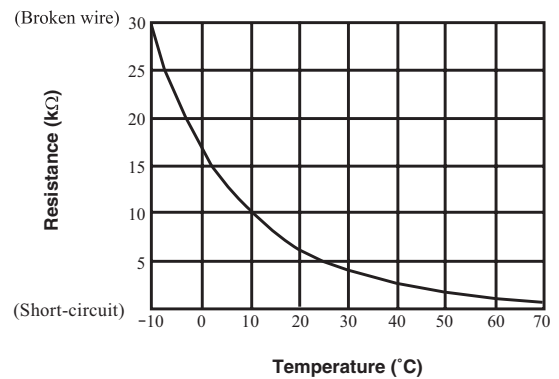
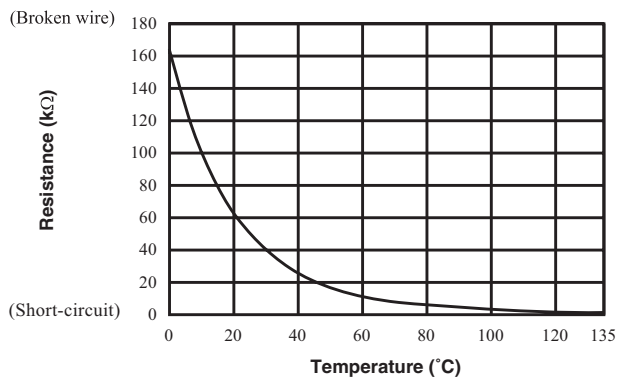

Indoor fan motor error

[Defective fan motor, connector poor connection, defective indoor unit PCB]

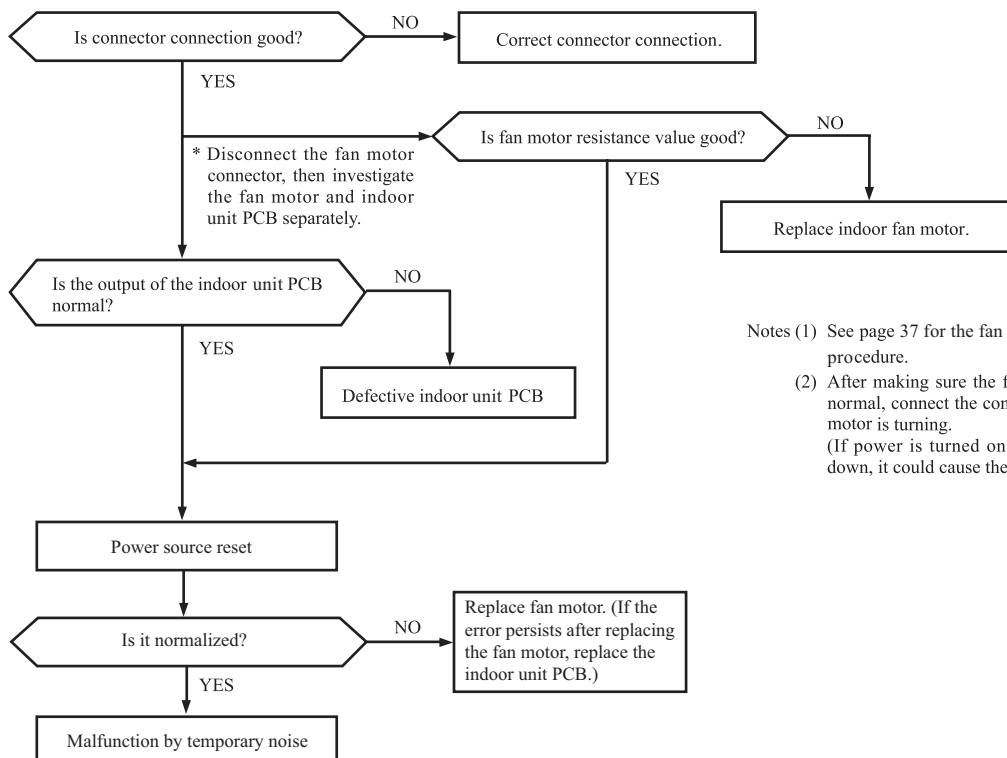

Notes (1) See page 37 for the fan motor and indoor unit PCB check procedure.
 (2) After making sure the fan motor and indoor unit PCB are normal, connect the connectors and confirm that the fan motor is turning.
 (If power is turned on while one or the other is broken down, it could cause the other to break down also.)

Overheat of compressor

[Gas shortage, defective discharge pipe temperature sensor]

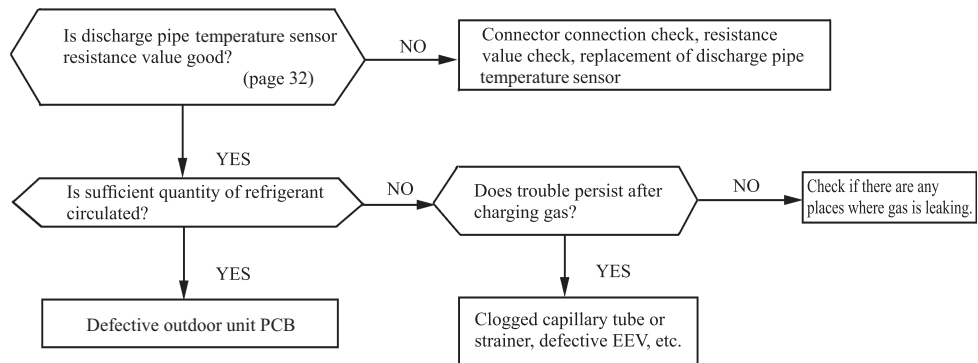

Error of signal transmission

[Wiring error including power cable, defective indoor/ outdoor unit PCB]

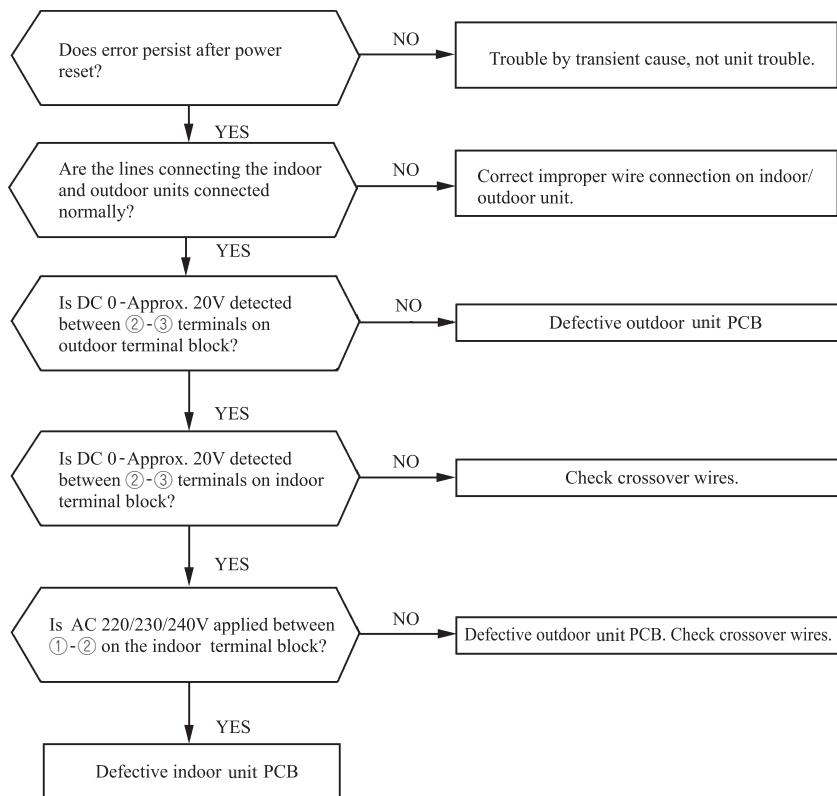

Trouble of outdoor unit

[Insufficient refrigerant amount, Faulty power transistor, Broken compressor wire]
 [Service valve close, Defective EEV, Defective outdoor unit PCB]

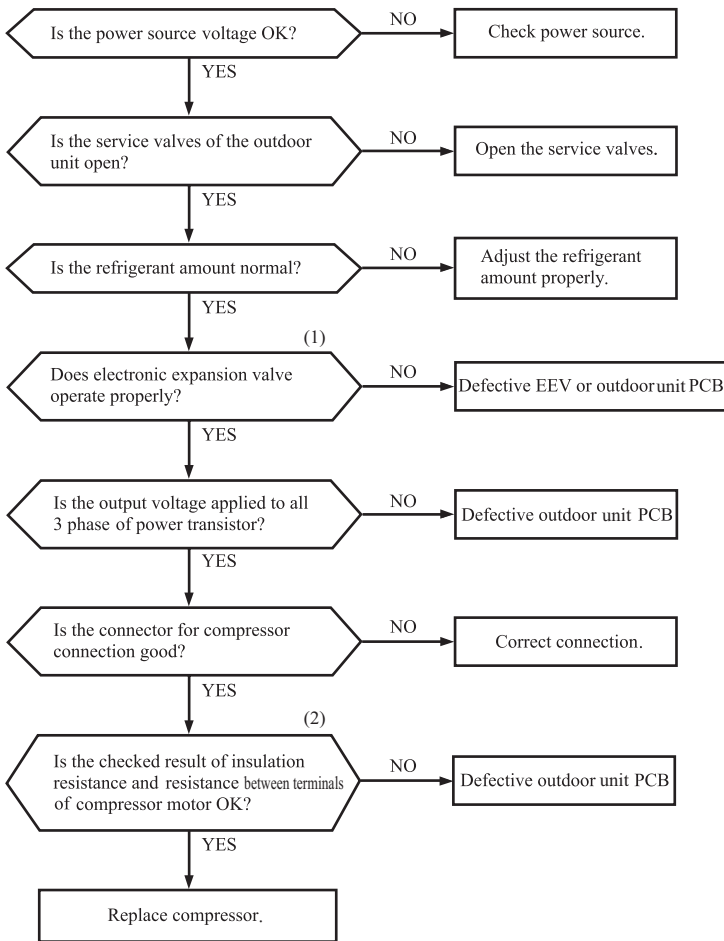

Proper power source voltages are as follows.
 (At the power source outlet)
 AC220V : AC 198-242V
 AC230V : AC 207-253V
 AC240V : AC 216-264V

- ◆ Judgment of refrigerant quantity
- (1) Phenomenon of insufficient refrigerant
 - (a) Loss of capacity
 - (b) Poor defrost operation
(Frost is not removed completely.)
 - (c) Longer time of hot keep
(5 minutes or more)
(Normal time: Approx. 1 – 1 minute and 30 seconds)

Notes (1) For inspection of electronic expansion valve, see page 42.
 (2) Check resistance between terminals, see page 33.

Outdoor fan motor error

[Defective fan motor, connector poor connection, defective outdoor unit PCB]

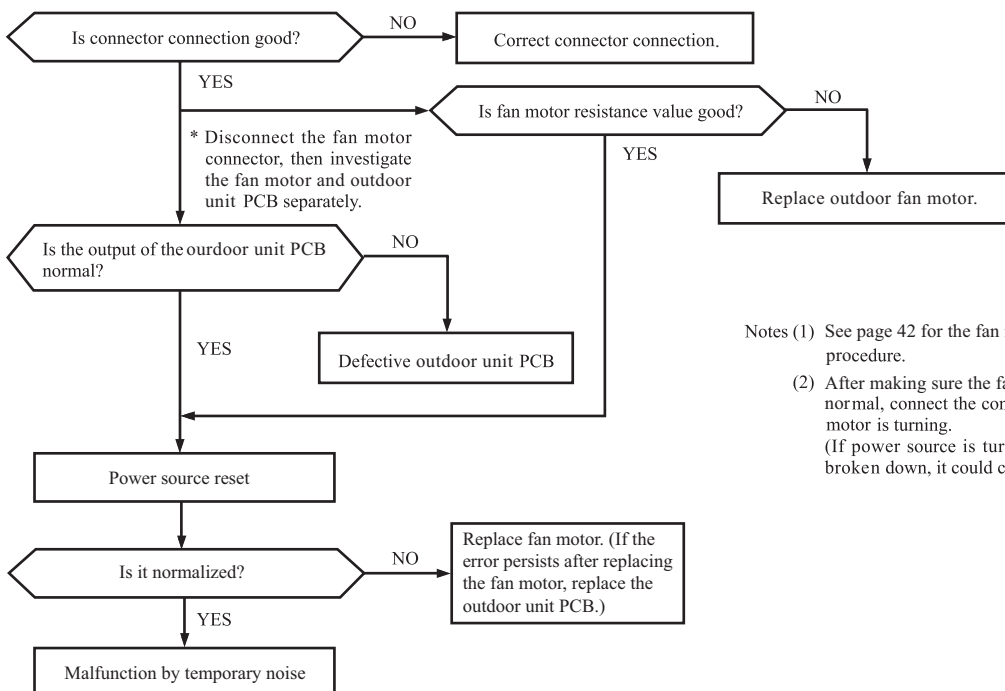

- Notes (1) See page 42 for the fan motor and outdoor unit PCB check procedure.
 (2) After making sure the fan motor and outdoor unit PCB are normal, connect the connectors and confirm that the fan motor is turning.
 (If power source is turned on while one or the other is broken down, it could cause the other to break down also.)

Rotor lock

[Defective compressor, defective outdoor unit PCB]

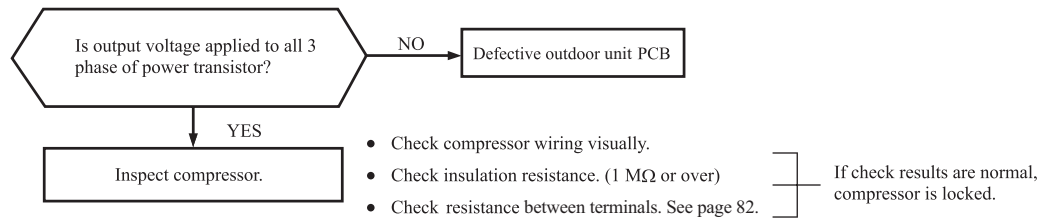

Service valve (gas side) closed operation

[Service valve (gas side) closed, Defective outdoor unit PCB]

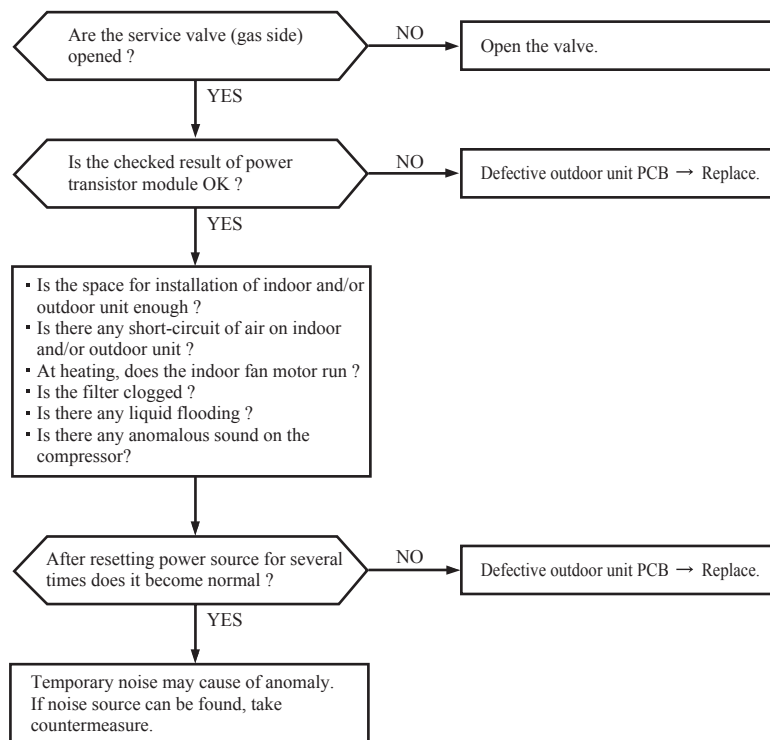

(8) Phenomenon observed after short-circuit, wire breakage on sensor

(a) Indoor unit

Sensor	Operation mode	Phenomenon	
		Short-circuit	Disconnected wire
Room air temperature sensor	Cooling	Release of continuous compressor operation command.	Continuous compressor operation command is not released.
	Heating	Continuous compressor operation command is not released.	Release of continuous compressor operation command.
Heat exchanger temperature sensor	Cooling	Freezing cycle system protection trips and stops the compressor.	Continuous compressor operation command is not released. (Anti-frosting)
	Heating	High pressure control mode (Compressor stop command)	Hot keep (Indoor fan stop)
Humidity sensor	Cooling	Refer to the table below.	Refer to the table below.
	Heating	Normal system operation is possible.	

■ Humidity sensor operation

Failure mode	Control input circuit reading	Air-conditioning system operation
Disconnected wire	① Disconnected wire	Humidity reading is 0%. Anti-condensation control is not done.
	② Disconnected wire	
	①② Disconnected wire	
Short-circuit	① and ② are short-circuited	Humidity reading is 100%. Anti-condensation control keep doing.

Remark: Do not perform a continuity check of the humidity sensor with a tester. If DC current is applied, it could damage the sensor.

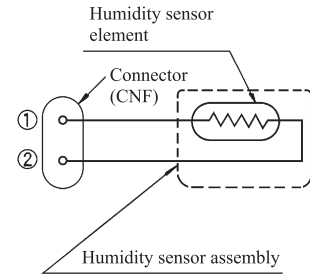

(b) Outdoor unit

Sensor	Operation mode	Phenomenon	
		Short-circuit	Disconnected wire
Heat exchanger temperature sensor	Cooling	Compressor stop.	Compressor stop.
	Heating	Defrost operation is not performed.	Defrost operation is performed for 10 minutes at approx. 35 minutes.
Outdoor air temperature sensor	Cooling	The compressor cannot pick up its speed owing to the current safe so that the designed capacity is not achieved.	Compressor stop.
	Heating	The compressor cannot pick up its speed owing to the heating overload protection so that the designed capacity is not achieved.	Defrost operation is performed for 10 minutes at approx. 35 minutes.
Discharge pipe temperature sensor	All modes	Compressor overload protection is disabled. (Can be operated.)	Compressor stop.

(9) Checking the indoor electrical equipment

(a) Indoor unit PCB check procedure

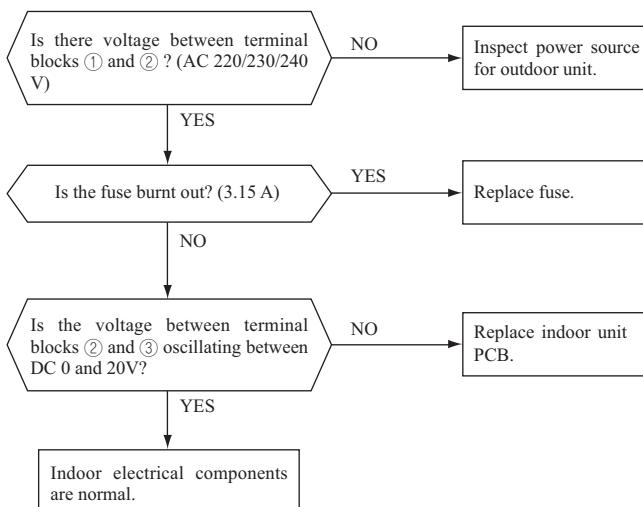

(b) Indoor fan motor check procedure

This is a diagnostic procedure for determining if the indoor fan motor or the indoor unit PCB is broken down.

1) Indoor unit PCB output check

- a) Turn off the power.
- b) Remove the front panel, then disconnect the fan motor lead wire connector.
- c) Turn on the power. If the unit operates when the ON/OFF button is pressed, if trouble is detected after the voltages in the following figure are output for approximately 30 seconds, it means that the indoor unit PCB is normal and the fan motor is broken down.

If the voltages in the following figure are not output at connector pins No. ①, ④ and ⑤, the indoor unit PCB has failed and the fan motor is normal.

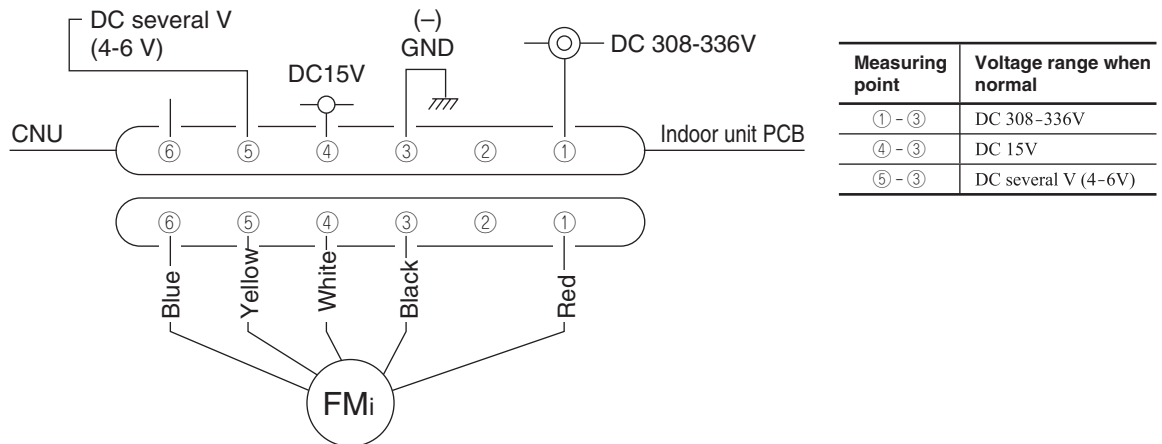

2) Fan motor resistance check

Measuring point	Resistance when normal
① - ③ (Red - Black)	20 MΩ or higher
④ - ③ (White - Black)	20 kΩ or higher

- Notes (1) Remove the fan motor and measure it without power connected to it.
 (2) If the measured value is below the value when the motor is normal, it means that the fan motor is faulty.

(10) How to make sure of wireless remote control

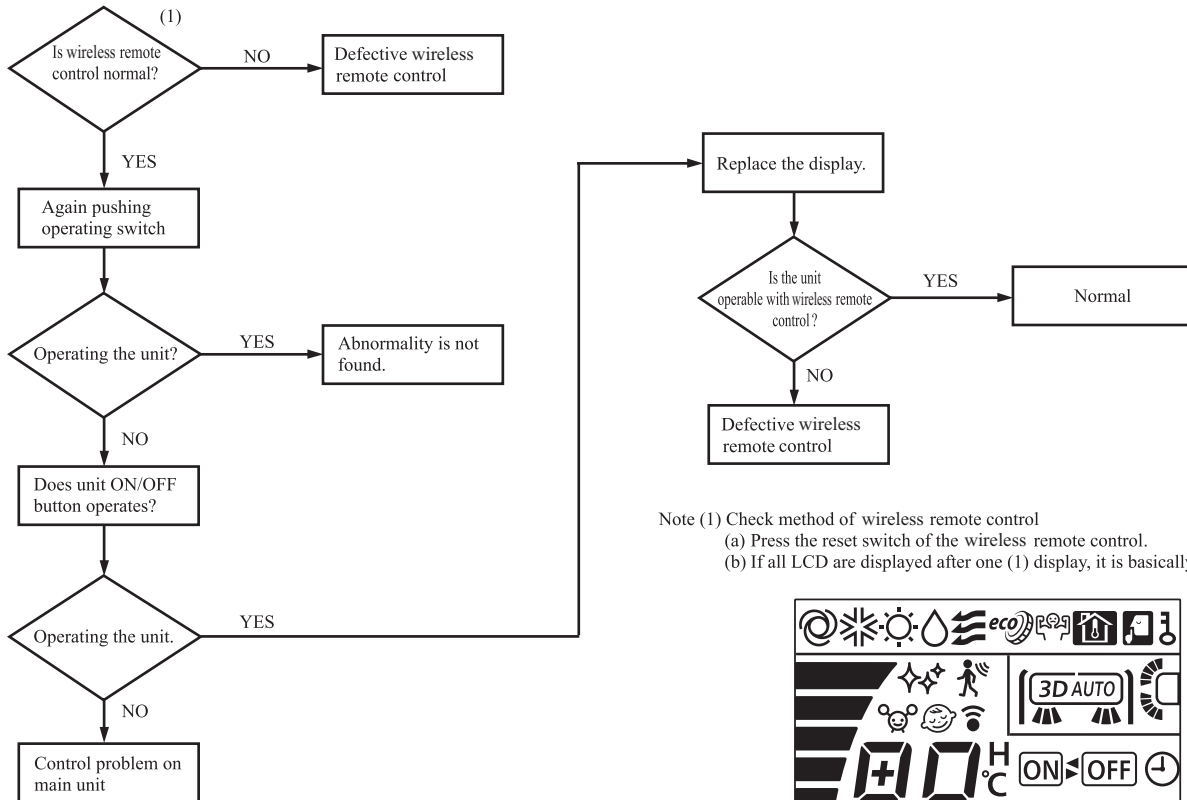

Note (1) Check method of wireless remote control
 (a) Press the reset switch of the wireless remote control.
 (b) If all LCD are displayed after one (1) display, it is basically normal.

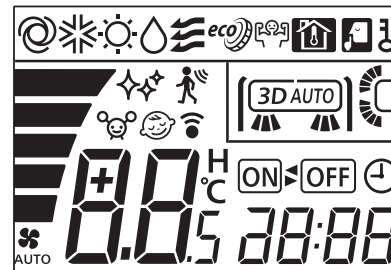

◆ Simplified check method of wireless remote control
 It is normal if the signal transmission section of the wireless remote control emits a whitish light at each transmission on the monitor of digital camera.

(11) Inspection procedure for blown fuse on the indoor and outdoor unit PCB

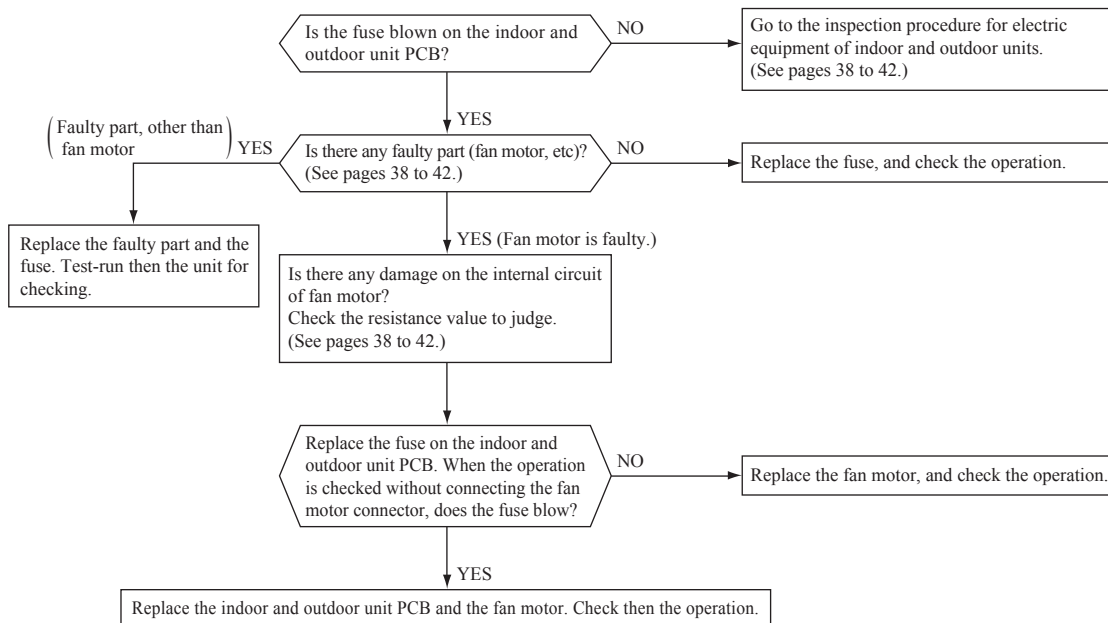

(12) Outdoor unit inspection points
Models SRC15ZTL-W, 20ZTL-W, 25ZTL-W, 35ZTL-W

◆ Check point of outdoor unit

⚠ WARNING – HIGH VOLTAGE

High voltage is produced in the control box. Don't touch electrical parts in the control box for 5 minutes after the unit is stopped.

◆ Power source and serial signal inspection

- ① to ④ : AC 220/230/240V
- ① to ② : AC 220/230/240V
- ② to ③ : Normal if the voltage oscillates between DC 0 and approx. 20V

Color symbol

Mark	Color
BK	Black
BL	Blue
BR	Brown
OR	Orange
RD	Red
WH	White
YE	Yellow
YG	Yellow/Green

◆ Voltage check in PCB

The normal range is as follows.
 Display Voltage range
 ① DC280V DC230V - DC310V
 ② DC 20V DC 18V - DC 22V
 ③ DC 13V DC 12V - DC 14V
 ④ DC 15V DC 14V - DC 16V
 ⑤ DC 5V DC 4V - DC 6V
 ⑥ DC 2.5V DC 2.3V - DC 2.5V

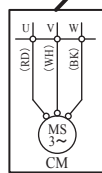
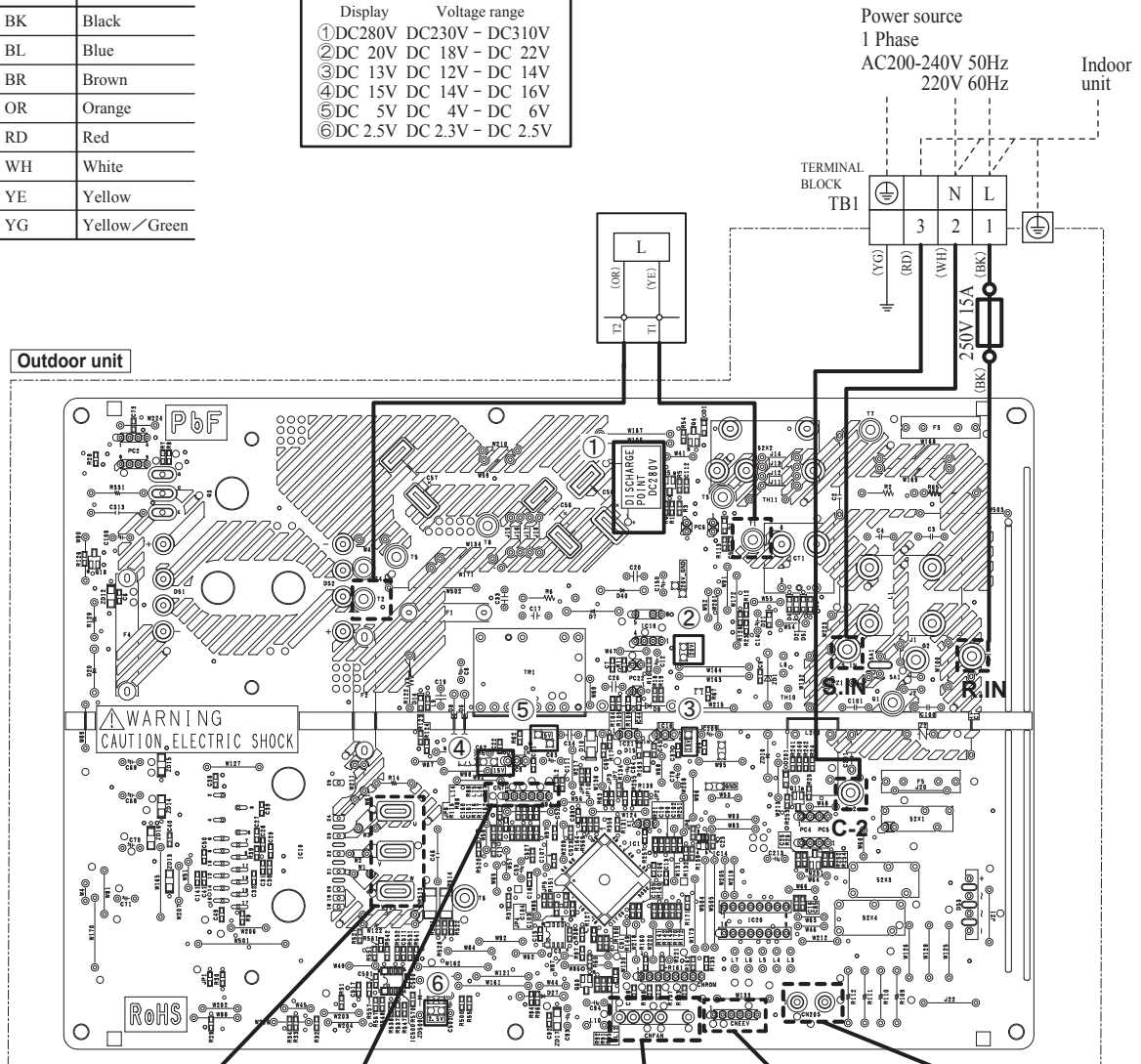

◆ Inspection power transistor
 Remove the faston terminal and test output voltage

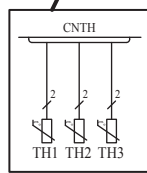

◆ Inspection of resistance value of sensor
 Remove the connector and check the resistance value. See the section of sensor characteristics on page 32.

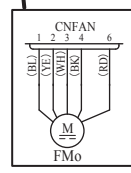

◆ Inspection of outdoor fan motor
 See page 42.

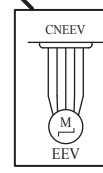

◆ Inspection of electronic expansion valve
 See page 42.

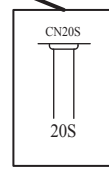

Model SRC50ZTL-W

◆ Check point of outdoor unit

⚠ WARNING – HIGH VOLTAGE

High voltage is produced in the control box. Don't touch electrical parts in the control box for 5 minutes after the unit is stopped.

Color symbol

Mark	Color
BK	Black
BL	Blue
RD	Red
WH	White
YE	Yellow
YG	Yellow/Green

◆ Voltage check in PCB

The normal range is as follows.

Display	Voltage range
① DC 280V	DC 230V – DC 310V
② DC 20V	DC 18V – DC 22V
③ DC 13V	DC 12V – DC 14V
④ DC 15V	DC 14V – DC 16V
⑤ DC 5V	DC 4V – DC 6V
⑥ DC 2.5V	DC 2.3V – DC 2.5V

◆ Inspection power transistor

Remove the faston terminal and test output voltage

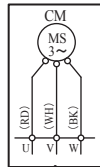

◆ Power source and serial signal inspection

- ① to ④ : AC 220/230/240V
- ① to ② : AC 220/230/240V
- ② to ③ : Normal if the voltage oscillates between DC 0 and approx. 20V

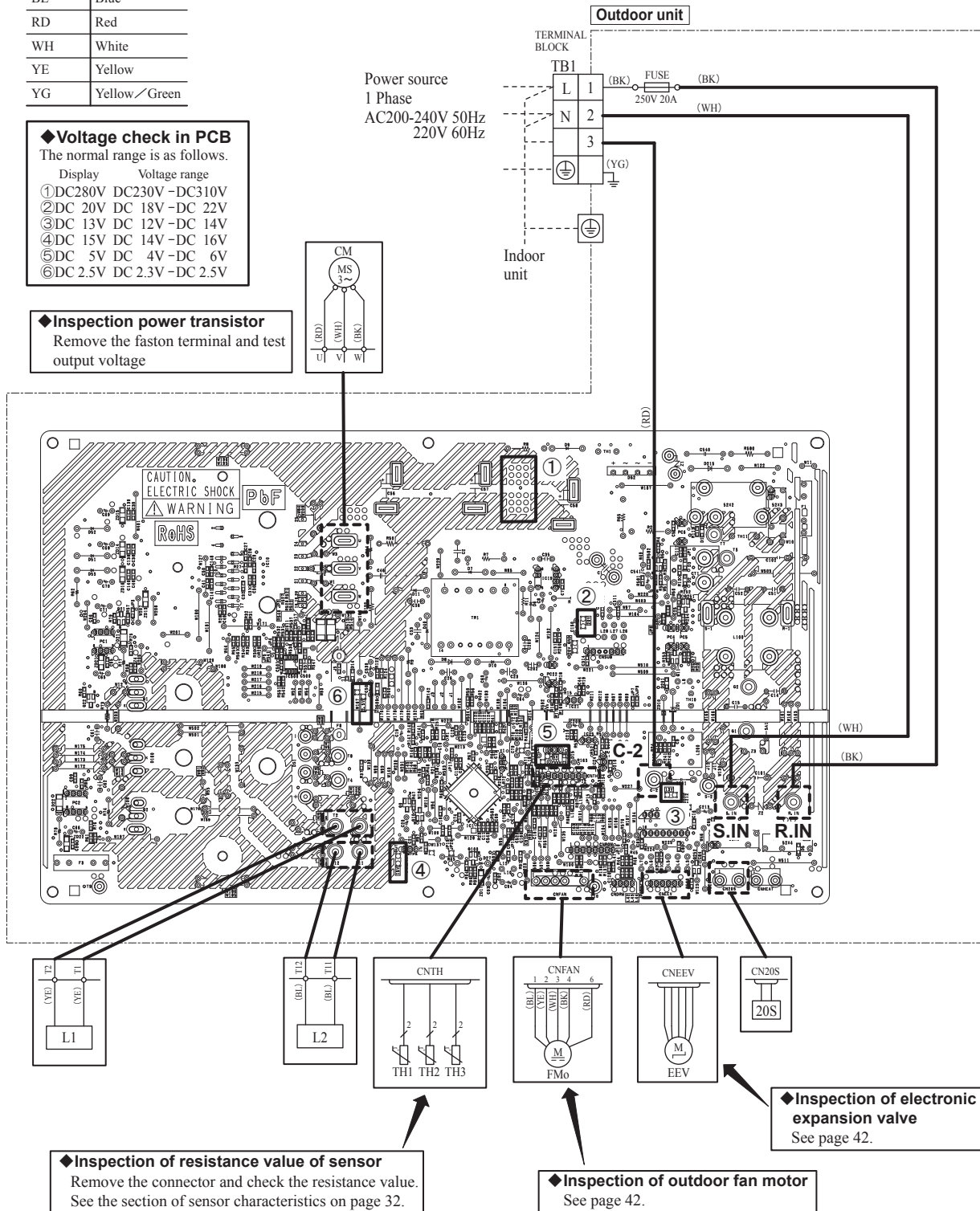

◆ Inspection of resistance value of sensor
Remove the connector and check the resistance value. See the section of sensor characteristics on page 32.

◆ Inspection of outdoor fan motor
See page 42.

◆ Inspection of electronic expansion valve
See page 42.

(a) Inspection of electronic expansion valve

Electronic expansion valve operates for approx. 10 seconds after the power on, in order to determine its aperture. Check the operating sound and voltage during the period of time. (Voltage cannot be checked during operation in which only the aperture change occurs.)

- (i) If it is heard the sound of operating electronic expansion valve, it is almost normal.
- (ii) If the operating sound is not heard, check the output voltage.

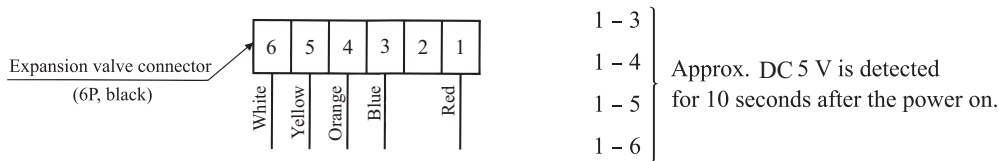

- (iii) If voltage is detected, the outdoor unit PCB is normal.
- (iv) If the expansion valve does not operate (no operating sound) while voltage is detected, the expansion valve is defective.

• Inspection of electronic expansion valve as a separate unit

Measure the resistance between terminals with an analog tester.

Measuring point	Resistance when normal
1-6	46 ± 4Ω (at 20°C)
1-5	
1-4	
1-3	

(b) Outdoor fan motor check procedure

- When the outdoor unit fan motor error is detected, diagnose which of the outdoor unit fan motor or outdoor unit PCB is defective.
- Diagnose this only after confirming that the indoor unit is normal.

(i) Outdoor unit PCB output check

- 1) Turn off the power.
- 2) Disconnect the outdoor fan motor connector CNFAN.
- 3) When the indoor unit is operated by inserting the power source plug and pressing (ON) the backup switch for more than 5 seconds, if the voltage of pin No. ② in the following figure is output for 30 seconds at 20 seconds after turning “ON” the backup switch, the outdoor unit PCB is normal but the fan motor is defective.

If the voltage is not detected, the outdoor unit PCB is defective but the fan motor is normal.

Note The voltage is output 3 times repeatedly. If it is not detected, the indoor unit displays the error message.

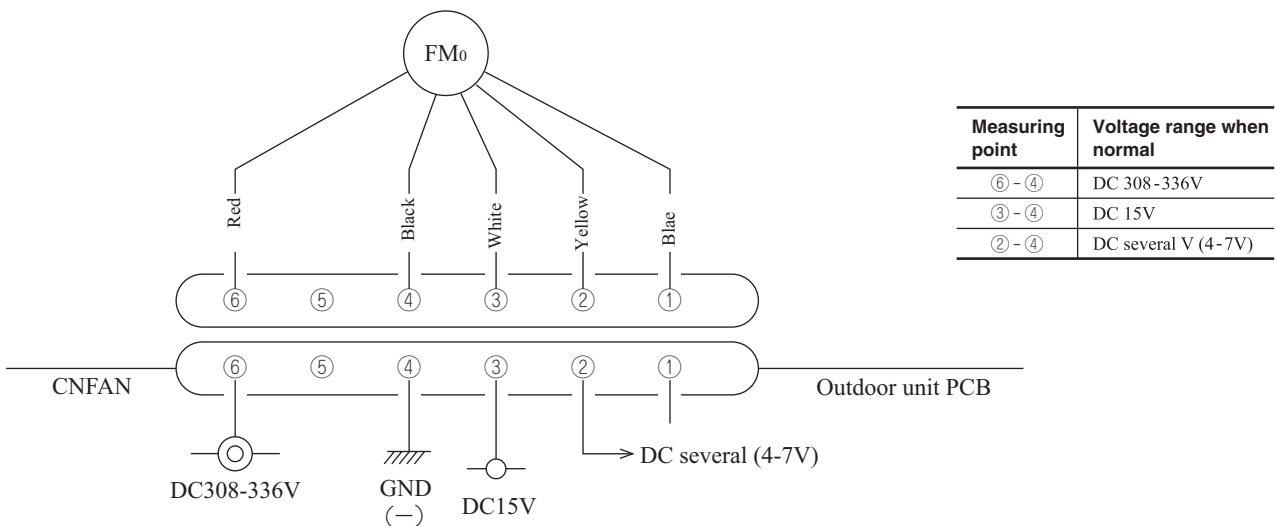

(ii) Fan motor resistance check

Measuring point	Resistance when normal
⑥ - ④ (Red - Black)	20 MΩ or higher
③ - ④ (White - Black)	20 kΩ or higher

- Notes (1) Remove the fan motor and measure it without power connected to it.
- (2) If the measured value is below the value when the motor is normal, it means that the fan motor is faulty.