

# 8. APPLICATION DATA

Models SRK25ZSP-W, 35ZSP-W, 45ZSP-W

RLC012A105

Model SRK25, 35, 45ZSP-W  
R32 REFRIGERANT USED

## SAFETY PRECAUTIONS

- Before installation, read the "SAFETY PRECAUTIONS" carefully and strictly follow it during the installation.
- Be sure to confirm no operation problem on the equipment after completing the installation. If unusual noise can be heard during the test run, consult the dealer.
- The precautionary items mentioned below are distinguished into two levels, **WARNING** and **CAUTION**.
  - **WARNING** indicates a potentially hazardous situation which, if not avoided, can result in serious consequences such as death or severe injury.
  - **CAUTION** indicates a potentially hazardous situation which, if not avoided, can result in personal injury or property damage.
- Both mention the important items to protect your health and safety. Therefore, strictly follow them by any means.











## WARNING













- |  |   |  |
|--|---|--|
| <ul style="list-style-type: none"> <li>• <b>Be sure to use only for residential purpose.</b><br/>If this unit is installed in inferior environment such as machine shop, vehicle (like ship), warehouse, etc., it can malfunction.</li> <li>• <b>Installation must be carried out by the qualified installer completely in accordance with the installation manual.</b><br/>Installation by non qualified person or incorrect installation can cause serious troubles such as water leak, electric shock, fire and personal injury.</li> <li>• <b>Be sure to wear protective goggles and gloves while performing installation work.</b><br/>Improper safety measures can result in personal injury.</li> <li>• <b>Use the original accessories and the specified components for the installation.</b><br/>Using parts other than those prescribed may cause water leak, electric shock, fire and personal injury.</li> <li>• <b>Do not install the unit near the location where leakage of flammable gases can occur.</b><br/>If leaked gases accumulate around the unit, it can cause fire resulting in property damage and personal injury.</li> <li>• <b>When installing the unit in small rooms, make sure that refrigerant density does not exceed the limit (Reference: ISO5149) in the event of leakage.</b><br/>If refrigerant density exceeds the limit, consult the dealer and install the ventilation system.</li> <li>• <b>Install the unit in a location where unit will remain stable, horizontal and free of any vibration transmission.</b><br/>Unsuitable installation location can cause the unit to fall resulting in material damage and personal injury.</li> <li>• <b>Do not run the unit with removed panels or protections.</b><br/>Touching rotating equipments, hot surfaces or high voltage parts can cause personal injury due to entrapment, burn or electric shock.</li> <li>• <b>This unit is designed specifically for R32.</b><br/>Using any other refrigerant can cause unit failure and personal injury.</li> <li>• <b>Do not vent R32 into atmosphere.</b><br/>R32 is a fluorinated greenhouse gas with a Global Warming Potential (GWP) = 675.</li> </ul> | <ul style="list-style-type: none"> <li>• <b>Make sure that no air enters the refrigerant circuit when the unit is installed and removed.</b><br/>If air enters the refrigerant circuit, the pressure in the refrigerant circuit will become too high, which can cause burst and personal injury.</li> <li>• <b>Be sure to use the prescribed pipes, flare nuts and tools for R32.</b><br/>Using existing parts (for R22 or R407C) can cause refrigerant circuit burst resulting in unit failure and personal injury.</li> <li>• <b>Be sure to connect both liquid and gas connecting pipes properly before operating the compressor.</b><br/><b>Do not open the liquid and gas service valves before completing piping work, and evacuation.</b><br/>If the compressor is operated when connecting pipes are not connected and service valves are open, air can be sucked into the refrigerant circuit which can cause anomalous high pressure resulting in burst or personal injury.</li> <li>• <b>Be sure to tighten the flare nuts to specified torque using the torque wrench.</b><br/>Tightening flare nuts with excess torque can cause burst and refrigerant leakage after a long period.</li> <li>• <b>During pump down work, be sure to stop the compressor before closing service valves and removing connecting pipes.</b><br/>If the connecting pipes are removed when the compressor is in operation and service valves are open, air can be sucked into the refrigerant circuit which can cause anomalous high pressure resulting in burst or personal injury.</li> <li>• <b>In the event of refrigerant leakage during installation, be sure to ventilate the working area properly.</b><br/>If the refrigerant comes into contact with naked flames, poisonous gases will be produced.</li> <li>• <b>Electrical work must be carried out by the qualified electrician, strictly in accordance with national or regional electricity regulations.</b><br/>Incorrect installation can cause electric shock, fire or personal injury.</li> <li>• <b>Make sure that earth leakage breaker and circuit breaker of appropriate capacities are installed.</b></li> </ul> | <ul style="list-style-type: none"> <li>• Circuit breaker should be able to disconnect all poles under over current. Absence of appropriate breakers can cause electric shock, personal injury or property damage.</li> <li>• <b>Be sure to switch off the power source in the event of installation, maintenance or service.</b><br/>If the power source is not switched off, there is a risk of electric shock, unit failure or personal injury.</li> <li>• <b>Be sure to tighten the cables securely in terminal block and relieve the cables properly to prevent overloading the terminal blocks.</b><br/>Loose connections or cable mountings can cause anomalous heat production or fire.</li> <li>• <b>Do not process, splice or modify the power cable, or share the socket with other power plugs.</b><br/>Improper power cable or power plug can cause fire or electric shock due to poor connection, insufficient insulation or over-current.</li> <li>• <b>Do not perform any change in protective device or its setup condition yourself.</b><br/>Changing protective device specifications can cause electric shock, fire or burst.</li> <li>• <b>Be sure to clamp the cables properly so that they do not touch any internal component of the unit.</b><br/>If cables touch any internal component, it can cause overheating and fire.</li> <li>• <b>Be sure to install service cover properly.</b><br/>Improper installation can cause electric shock or fire due to intrusion of dust or water.</li> <li>• <b>Be sure to use the prescribed power and connecting cables for electrical work.</b><br/>Using improper cables can cause electric leak or fire.</li> <li>• <b>This appliance must be connected to main power source by means of a circuit breaker or switch with a contact separation of at least 3 mm.</b><br/>Improper electrical work can cause unit failure or personal injury.</li> <li>• <b>When plugging this unit, a plug conforming to the standard IEC60884-1 must be used.</b><br/>Using improper plug can cause electric shock or fire.</li> <li>• <b>Be sure to connect the power source cable with power source properly.</b><br/>Improper connection can cause intrusion of dust or water resulting in electric shock or fire.</li> </ul> |
|--|---|--|

## ⚠ CAUTION

<p>It can cause corrosion of heat exchanger and damage to plastic parts.</p> <ul style="list-style-type: none"> <li>• <b>Take care when carrying the unit by hand.</b> If the unit weight is more than 20 kg, it must be carried by two or more persons. Do not carry the unit by the plastic straps. Always use the carry handle.</li> <li>• <b>Do not install the unit close to the equipments that generate electromagnetic waves and/or high-harmonic waves.</b> Equipment such as inverters, standby generators, medical high frequency equipments and telecommunication equipments can affect the system, and cause malfunctions and breakdowns. The system can also affect medical equipment and telecommunication equipment, and obstruct its function or cause jamming.             <ul style="list-style-type: none"> <li>• <b>Do not install the unit in the locations where:</b> <ul style="list-style-type: none"> <li>• There are heat sources nearby.</li> <li>• Unit is directly exposed to rain or sunlight.</li> <li>• There is any obstacle which can prevent smooth air circulation from inlet and outlet side of the unit.</li> <li>• Unit is directly exposed to oil mist and steam such as kitchen.</li> <li>• Chemical substances like ammonia (organic fertilizer), calcium chloride (snow melting agent) and acid (sulfurous acid etc.), which can harm the unit, will generate or accumulate.</li> <li>• Drain water can not be discharged properly.</li> <li>• TV set or radio receiver is placed within 1 m.</li> <li>• Height above sea level is more than 1000 m.</li> </ul> </li> </ul> </li> </ul>	<p>It can cause performance degradation, corrosion and damage of components, unit malfunction and fire.</p> <ul style="list-style-type: none"> <li>• <b>Dispose of all packing materials properly.</b> Packing materials contain nails and wood which can cause personal injury. Keep the polybag away from children to avoid the risk of suffocation.</li> <li>• <b>Do not put anything on the outdoor unit.</b> Object may fall causing property damage or personal injury.</li> <li>• <b>Do not touch the aluminum fin of the outdoor unit.</b> Aluminium fin temperature is high during heating operation. Touching fin can cause burn.</li> <li>• <b>Do not touch any refrigerant pipe with your hands when the system is in operation.</b> During operation the refrigerant pipes become extremely hot or extremely cold depending on the operating condition. Touching pipes can cause personal injury like burn (hot/cold).</li> <li>• <b>Install isolator or disconnect switch on the power source wiring in accordance with the local codes and regulations.</b> The isolator should be locked in OFF state in accordance with EN60204-1.</li> </ul>
---	--

## ACCESSORIES AND TOOLS

Standard accessories (supplied with indoor unit)	
(1) Installation board	1pc  2pcs 
(2) Remote control	1pc  2pcs 
(3) Remote control holder	1pc  2pcs 
(4) Tapping screws (for installation board 64 X 25 mm)	5pcs  1pc 
(5) Wood screws (for remote control holder ø3.5 X 16 mm)	2pcs 
Standard accessories (supplied with outdoor unit)	
(1) Drain grommet	1pc  (2) Drain elbow 1pc 

Locally procured parts	
(a) Sleeve (1pc)	
(b) Sealing plate (1pc)	
(c) Inclination plate (1pc)	
(d) Putty	
(e) Connecting cable	
(f) Drain hose (extension hose)	
(g) Piping cover (for insulation of connection piping)	
(h) Clamp and screw (for finishing work)	
(i) Anchor bolt (M10-M12) x 4pcs	
(j) Electrical tape	
(k) Connecting pipe	
(l) Power cable	

Tools for installation work	
Plus headed driver	Hole core drill (65 mm in diameter)
Knife	Wrench key (Hexagon) [4 mm]
Saw	Flaring tool set*
Tape measure	Gas leak detector*
Torque wrench (14.0-62.0 N.m (1.4-6.2 kgf.m))	Pipe bender
Plier	Gauge for projection adjustment (Used when flare is made by using conventional flare tool)
Pipe cutter	Spanner wrench
Flare adjustment gauge	Charge hose *
Vacuum pump*	Vacuum pump adapter* (Anti-reverse flow type)
Gauge manifold *	

\* Designed specifically for R32 or R410A

## SELECTING OF INSTALLATION LOCATION

After getting customer's approval, select installation location according to following guidelines.

### 1. Indoor unit

- Where there is no obstruction to the air flow and where the cooled and heated air can be evenly distributed.
- A solid place where the unit or the wall will not vibrate.
- A place where there will be enough space for servicing. (Where space mentioned on the right side can be secured.)
- Where it is easy to conduct wiring and piping work.
- A place where unit is not directly exposed to sunlight or street light.
- A place where it can be easily drained.
- A place separated at least 1 m away from the television or the radio. (To prevent interference to images and sounds.)
- A place where this unit is not affected by the high frequency equipment or electric equipment.
- Avoid installing this unit in place where there is much oil mist.
- A place where there is no electric equipment or household.
- Install the indoor unit on the wall where the height from the floor to the bottom of the unit is more than 180 cm.

### 2. Remote control

- A place where the air-conditioner can receive the signal surely during operating the remote control.
- A place where it is not affected by the TV, radio etc.
- Do not place where it is exposed to direct sunlight or near heat devices such as a stove.

### 3. Outdoor unit

- Select the suitable installation location where:
- Unit will be stable, horizontal and free of any vibration transmission.
  - There is no obstacle which can prevent smooth air circulation from inlet and outlet side of the unit.
  - There is enough space for service and maintenance of unit.
  - Neighbours are not bothered by noise or air generating from the unit.
  - Outlet air of the unit does not blow directly to animals or plants.
  - Drain water can be discharged properly.
  - There is no risk of flammable gas leakage.
  - There are no other heat sources nearby.
  - Unit is not directly exposed to rain or sunlight.
  - Unit is not directly exposed to oil mist and steam.
  - Chemical substances like ammonia (organic fertilizer), calcium chloride (snow melting agent) and acid (sulfurous acid etc.), which can harm the unit, will not generate or accumulate.
  - Unit is not directly exposed to corrosive gases (like sulphide gas, chloride gas), sea breeze or salty atmosphere.
  - No TV set or radio receiver is placed within 1 m.
  - Unit is not affected by electromagnetic waves and/or high-harmonic waves generated by other equipments.
  - Strong wind does not blow against the unit outlet.
  - Heavy snowfalls do not occur (if installed, provide proper protection to avoid snow accumulation).
  - There must be 1 meter or larger space between the unit and the wall in at least 1 of the 4 sides.
  - Walls surrounding the unit from 4 sides is not acceptable. The wall height on the outlet side should be 1200 mm or less. Refer to the following figure and table for details.

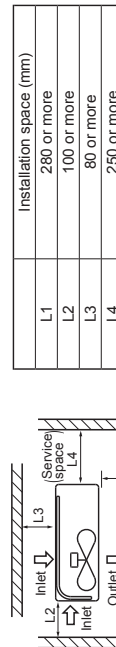

	Installation space (mm)
L1	280 or more
L2	100 or more
L3	80 or more
L4	250 or more

### NOTE

When more than one unit are installed side by side, provide a 250 mm or wider interval between them as a service space.

### CAUTION

When more than one unit are installed in parallel directions, provide sufficient inlet space so that short-circuiting may not occur.

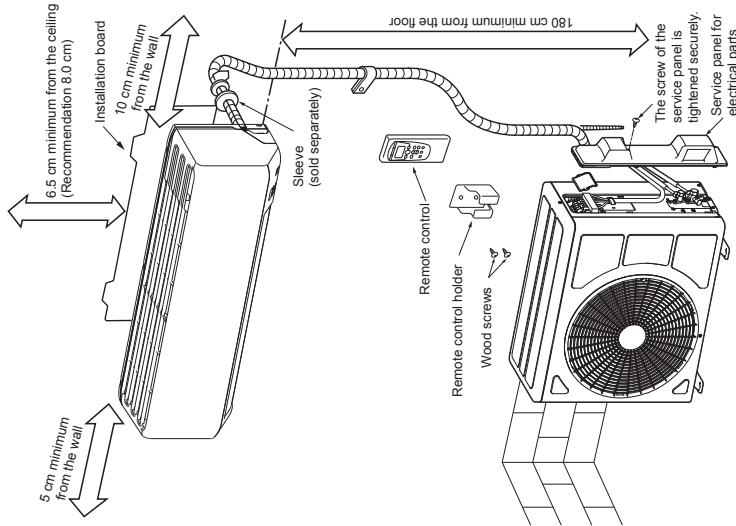

### Note as a unit designed for R32

- Do not use any refrigerant other than R32. R32 will rise to pressure about 1.6 times higher than that of a conventional refrigerant. A cylinder containing R32 has a light blue indication mark on the top.
- Do not use a charge cylinder. The use of a charge cylinder will cause the refrigerant composition to change, which results in performance degradation.
- In charging refrigerant, always take it out from a cylinder in the liquid phase.
- All indoor units must be models designed exclusively for R32. Check connectable indoor unit models in a catalog, etc. (A wrong indoor unit, if connected into the system, will impair proper system operation.)

### Limitation of the piping length

Model	DXK09, SRK25, LMK09	DXK12, SRK35, LMK12	DXK15, SRK45, LMK15
Total one way length	MAX. 15 m	MAX. 15 m	MAX. 25 m
Vertical height difference	MAX. 10 m	MAX. 10 m	MAX. 15 m
Additional refrigerant	Less than 10 m: Not required More than 10 m: 20 g/m	Not required	Less than 15 m: Not required More than 15 m: 20 g/m

### Charging refrigerant

- (1) Charge the R32 refrigerant in liquid phase from service port with both liquid and gas service valves shut. Since R32 refrigerant must be charged in the liquid phase, make sure that refrigerant is discharged from the cylinder in the liquid phase all the time.
- (2) When it is difficult to charge a required refrigerant amount, fully open both liquid and gas service valves and charge refrigerant, while running the unit in the cooling mode. When refrigerant is charged with the unit being run, complete the charge operation within 30 minutes.
- (3) Write the additional refrigerant charge calculated from the connecting pipe length on the label attached on the service cover.

### CAUTION

- Running the unit with an insufficient quantity of refrigerant for a long time can cause unit malfunction.
- Do not charge more than the maximum refrigerant amount. It can cause unit malfunction.

### DRAIN PIPING WORK (if necessary)

Carry out drain piping work by using a drain elbow and a drain grommet supplied separately as accessories if condensed water needs to be drained out.

- (1) Install drain elbow and drain grommet.
- (2) Seal around the drain elbow and drain grommet with putty or adequate caulking material.

Do not put a grommet on this hole.  
This is a supplementary drain hole to discharge drain water, when a large amount of it is gathered.

<DXK09/12, SRK25/35, LMK09/12>

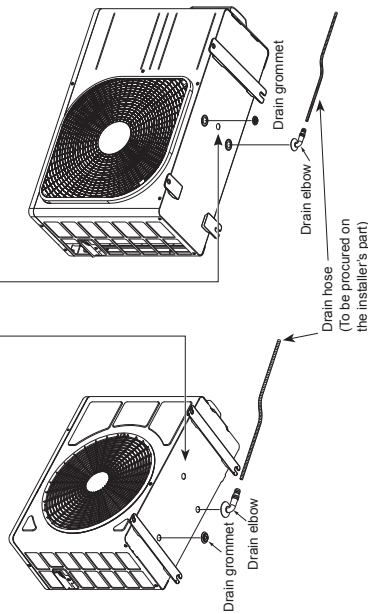

<DXK15, SRK45, LMK15>

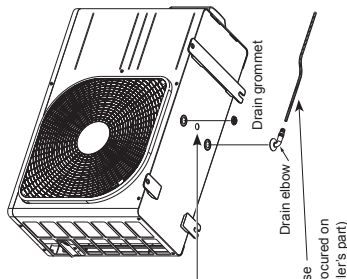

### CAUTION

Do not use drain elbow and drain grommet if there is a possibility to have several consecutive days or sub zero temperature. (There is a risk of drain water freezing inside and blocking the drain.)

### INSTALLING REMOTE CONTROL

#### Mount the batteries

- (1) Slide and take out the cover of backside.
- (2) Mount the batteries [R03 (AAA, Micro), \* 2 pieces] in the body properly.  
(Fit the poles with the indication marks + & -)
- (3) Set the cover again.

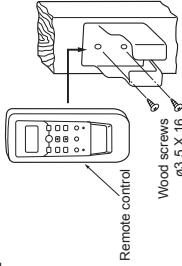

#### Installing remote control holder

- (1) Select the place where the unit can receive signals.
- (2) Fix the holder to pillar or wall with wood screws.

### HOW TO REMOVE AND INSTALL FRONT PANEL

#### 1. Removing

- (1) Remove the air inlet panel and the air filters.
- (2) Remove the 2 screws.
- (3) Remove the 3 upper latches and then front panel can be removed.

#### 2. Installing

- (1) Cover the unit with the front panel and fix 3 upper latches.
- (2) Secure the front panel with the 2 screws.
- (3) Install the air inlet panel and the air filters.

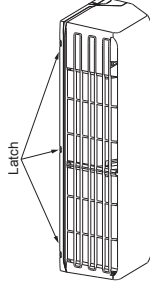

### PUMP DOWN WORK

For the environmental protection, be sure to pump down when relocating or disposing of the unit. Pump down is the method of recovering refrigerant from the indoor unit to the outdoor unit before the connecting pipes are removed from the unit. When pump down is carried out, forced cooling operation is needed.

#### Forced cooling operation

- (1) Turn off the power source and turn it on again after 1 minute.
- (2) Press the ON/OFF button continuously for at least 5 seconds. Then operation will start.

For the detail of pump down, refer to the installation manual of outdoor unit.

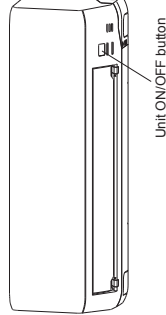

### 1. INSTALLING INSTALLATION BOARD

- Installation board should be installed on the wall which can support the weight of the indoor unit.
- Adjustment of the installation board in the horizontal direction is to be conducted with five screws in a temporary standard hole.
- With the standard hole as a center, adjust the board and level it.

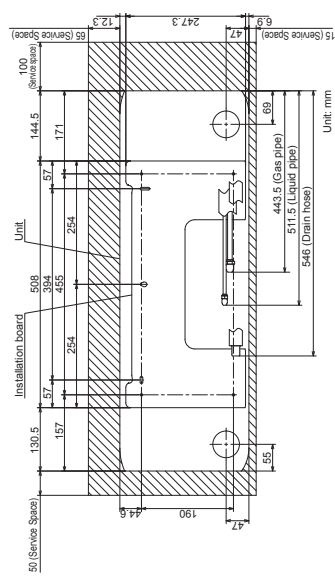
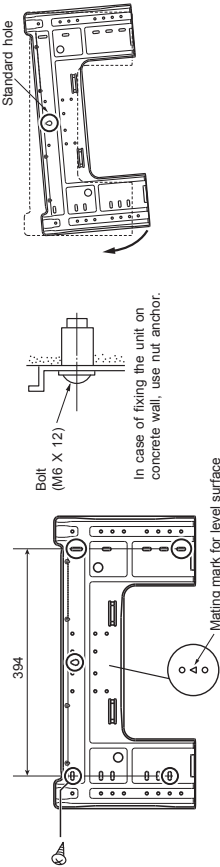

### CAUTION

Improper adjustment of the installation board can cause water leakage.

## 2. DRILLING HOLE AND FIXTURE OF SLEEVE

When drilling the wall that contains a metal lath, wire lath or metal plate, be sure to use sealing plate, sleeve and inclination plate (Locally procured parts).

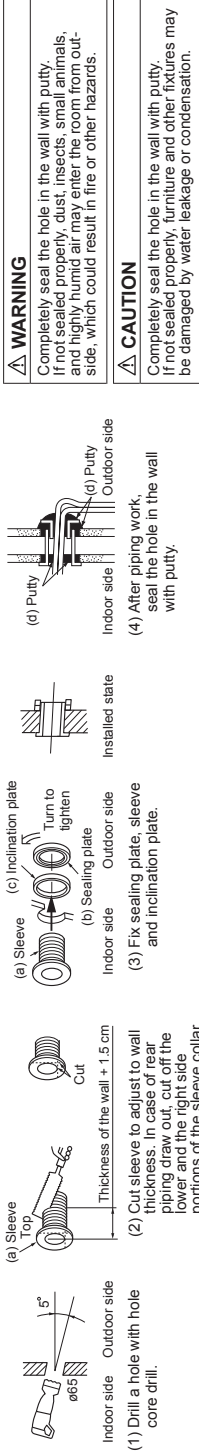

**WARNING**  
Completely seal the hole in the wall with putty. If not sealed properly, dust, insects, small animals, and highly humid air may enter the room from outside, which could result in fire or other hazards.

**CAUTION**  
Completely seal the hole in the wall with putty. If not sealed properly, furniture and other fixtures may be damaged by water leakage or condensation.

## 3. ELECTRICAL WIRING WORK

• Before installation, make sure that the power source complies with the air-conditioner's power specification.  
• Carry out electrical wiring work according to following guidelines.

### 1. Preparing cable

- Selecting cable  
Select the power source cable in accordance with the specifications mentioned below.  
(a) Power source cable  
When selecting the power source cable length, make sure that voltage drop is less than 2%.  
(b) Connecting cable  
\* 1 Earth wire is included (Yellow/Green).  
\* 4 cores, 1.5 mm<sup>2</sup>, conformed with 60245 IEC57  
If the wire length gets longer, increase the wire diameter.
- Arrange each wire length as shown below.  
Make sure that each wire is stripped 10 mm from the end.
- Attach round crimp-type terminal to each wire as shown in the below.  
Select the size of round crimp-type terminal after considering the specifications of terminal block and wire diameter.  
<Connecting cable (4 wires)>  
<Power source cable (3 wires)>  
<Wire end>

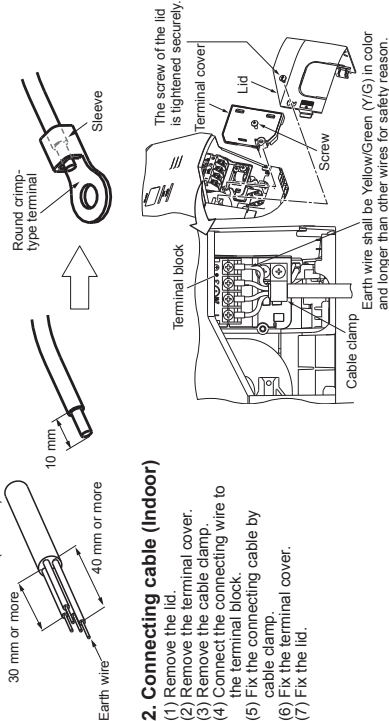

### 2. Connecting cable (Indoor)

- Remove the lid.
- Remove the terminal cover.
- Remove the cable clamp.
- Connect the connecting wire to the terminal block.
- Fix the connecting cable by cable clamp.
- Fix the terminal cover.
- Fix the lid.

### NOTE

Take care not to confuse the terminal numbers for indoor and outdoor connections.

### WARNING

Incorrect wiring connection can cause malfunction or fire.

### WARNING

- Make sure that all the electrical work is carried out in accordance with the national or regional electrical standards.
- Make sure that the earth leakage breaker and circuit breaker of appropriate capacities are installed. (Refer to the table given below).
- Do not turn on the power until the electrical work is completed.
- Do not use a condensate capacitor for power factor improvement under any circumstances. (It does not improve power factor. Moreover, it can cause an abnormal overheating accident.)

Breaker specifications

Model	Phase	Earth leakage breaker	Circuit breaker
DXK09/12, SRK25/35, LMK09/12	Single phase	Leakage current: 30 mA, 0.1 sec or less	Over current: 16 A Over current: 20 A

Main fuse specification

Specification	Parts No.	Code on LABEL_WIRING
250 V 15 A	SSA564A136	F7

### 3. Connecting cable (Outdoor)

- Remove the service cover.
- Connect the cables according to the instructions and figures given below.  
(a) Connect the earth wire of power source cable.  
Connect the earth wire of connecting cable to the remaining two wires of power source cable.  
Keep the remaining two wires (N and L) of power source cable.  
(b) Connect the remaining two wires (N and L) of power source cable.  
(c) Connect the wires of connecting cable. Make sure that for each wire, outdoor and indoor side terminal numbers match.
- Fasten the cables properly with cable clamps so that no external force may work on terminal connections. Moreover, make sure that cables do not touch the piping, etc. When cables are connected, make sure that all electrical components within the electrical component box are free of loose connector coupling or terminal connection.

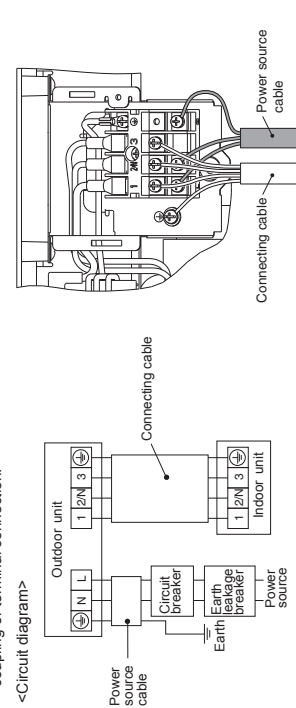

## 4. FORMING PIPING AND DRAIN HOSE

### 1. Forming piping

Piping is possible in the right, rear, downward, left, left rear or left downward direction.

#### NOTE

Sufficient care must be taken not to damage the panels when connecting pipes.

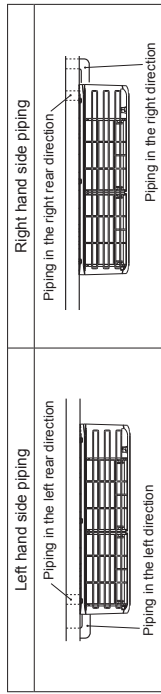
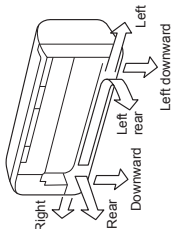

### Forming of pipings

- Hold the bottom of the piping and fix direction before stretching it and shaping it.

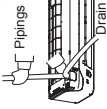

### Taping of the exterior

- Tape only the portion that goes through the wall.
- Always tape the wiring with the piping.



### 2. Drain change procedures

- Remove the screw and drain hose.
- Remove the drain cap by hand or pliers.
- Insert the drain cap which was removed at procedure (2) securely using a hexagonal wrench etc.
- Install the drain hose and screw securely.

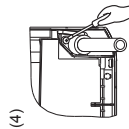
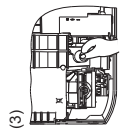
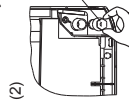
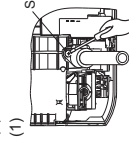

#### CAUTION

Incorrect installation of drain hose and cap can cause water leakage.

## 5. DRAINAGE WORK

- Arrange the drain hose in a downward angle.
- Avoid the following drain piping.

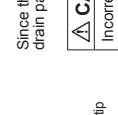
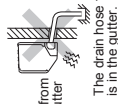

- Pour water to the drain pan located under the heat exchanger, and ensure that the water is discharged outdoor.
- When extended drain hose is present inside the room, insulate it securely with heat insulator available in the market.

Since this air-conditioner is designed to collect dew drops on the rear surface to the drain pan, do not install the connecting wire above the gutter.

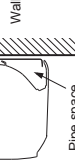

#### CAUTION

Incorrect drainage work can cause water leakage.

## 6. INSTALLING INDOOR UNIT

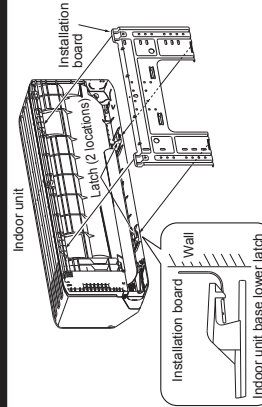

### Installation steps

- Pass the pipe through the hole in the wall, and hook the upper part of the indoor unit to the installation board.

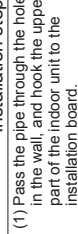

- Gently push the lower part to secure the unit.



### How to remove the indoor unit from the installation board

- Push up at the marked portion of the indoor unit base lower latch, and slightly pull it toward you. (Both right and left hand sides) (The indoor unit base lower latch can be removed from the installation board.)
- Push up the indoor unit upward so that it can be removed from the installation board.

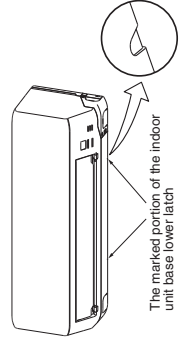

## 7. CONNECTING PIPING WORK

### 1. Preparation of connecting pipe

#### 1.1. Selecting connecting pipe

Select connecting pipe according to the following table.

	Model DXK09/12	Model DXK15
Gas pipe	SRK25/35 LMK09/12	SRK45 LMK15
Liquid pipe	ø9.52 ø6.35	ø12.7 ø6.35

- Pipe wall thickness must be greater than or equal to 0.8 mm.
- Pipe material must be O-type (Phosphorus deoxidized seamless copper pipe ICS 23.040.15, ICS 77.150.30).

#### 1.2. Cutting connecting pipe

- (1) Cut the connecting pipe to the required length with pipe cutter.
- (2) Hold the pipe downward and remove the burrs. Make sure that no foreign material enters the pipe.
- (3) Cover the connecting pipe ends with the tape.

### 2. Piping work

#### 2.1. Flaring pipe

- (1) Take out flare nuts from the service valves of indoor unit and engage them onto connecting pipes.
- (2) Flare the pipes according to table and figure shown below.  
Flare dimensions for R32 are different from those for conventional refrigerant. Although it is recommended to use the flaring tools designed specifically for R32, conventional flaring tools can also be used by adjusting the dimension B with a flare adjustment gauge.

Copper pipe outer diameter	A	B [ Rigid (clutch) type ]	
		R32	Conventional
ø6.35	9.1	0-0.5	1.0-1.5
ø9.52	13.2		
ø12.7	16.6		

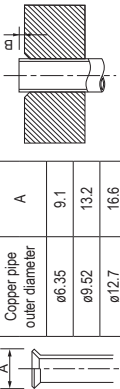

#### 2.2. Connecting pipes

- (1) Connect pipes on both liquid and gas sides.
- (2) Tighten nuts to specified torque shown in the table below.

Service valve size (mm)	Tightening torque (N·m)
ø6.35 (1/4")	14-18
ø9.52 (3/8")	34-42
ø12.7 (1/2")	49-61

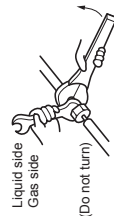

#### ⚠ CAUTION

- Do not apply refrigerating machine oil to the flared surface. It can cause refrigerant leakage.
- Do not apply excess torque to the flared nuts. The flared nuts may crack resulting in refrigerant leakage.

### 3. Heating and condensation prevention

- (1) Dress the connecting pipes (both liquid and gas pipes) with insulation to prevent it from heating and dew condensation.  
Use the heat insulating material which can withstand 120 °C or higher temperature. Make sure that insulation is wrapped tightly around the pipes and no gap is left between them.
- (2) Wrap the refrigerant pipings of indoor unit with indoor unit heat insulation using tape.
- (3) Cover the flare-connected joints (indoor side) with the indoor unit heat insulation and wrap it with an insulation pad (standard accessory provided with indoor unit).
- (4) Wrap the connecting pipes, connecting cable and drain hose with the tape.

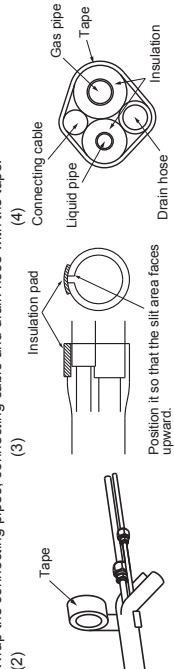

Position it so that the slit area faces upward.

#### NOTE

Locations where relative humidity exceeds 70 %, both liquid and gas pipes need to be dressed with 20 mm or thicker heat insulation materials.

#### ⚠ CAUTION

- Improper insulation can cause condensate (water) formation during cooling operation. Condensate can leak or drip causing damage to household property.
- Poor heat insulating capacity can cause pipe outer surface to reach high temperature during heating operation. It can cause cable deterioration and personal injury.

### 4. Finishing work

- (1) Make sure that the exterior portion of connecting pipes, connecting cable and drain hose is wrapped properly with tape. Shape the connecting pipes to match the contours of the pipe assembly route.
- (2) Fix the pipe assembly with the wall using clamps and screws. Pipe assembly should be anchored every 1.5 m or less to isolate the vibration.
- (3) Install the service cover securely. Water may enter the unit if service cover is not installed properly, resulting in unit malfunction and failure.

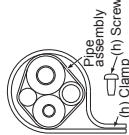

#### ⚠ WARNING

- To avoid the risk of fire or explosion, the flared connection must/shall be installed outdoors.
- Reusable mechanical connectors and flared joints are not allowed indoors.

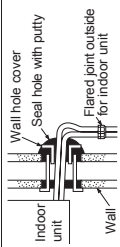

#### ⚠ CAUTION

Make sure that the connecting pipes do not touch the components within the unit. If pipes touch the internal components, it may generate abnormal sounds and/or vibrations.

### 5. Evacuation

- (1) Connect vacuum pump to gauge manifold. Connect charge hose of gauge manifold to service port of outdoor unit.
- (2) Run the vacuum pump for at least one hour after the vacuum gauge shows -0.1 MPa (-76 cm Hg).
- (3) Confirm that the vacuum gauge indicator does not rise even if the system is left for 15 minutes or more. Vacuum gauge indicator will rise if the system has moisture left inside or has a leakage point. Check the system for the leakage point. If leakage point is found, repair it and return to (1) again.
- (4) Close the Handle Lo and stop the vacuum pump.  
Keep this state for a few minutes to make sure that the compound pressure gauge pointer does not swing back.
- (5) Remove valve caps from liquid service valve and gas service valve.
- (6) Turn the liquid service valve's rod 90 degree counterclockwise with a hexagonal wrench key to open valve. Using soapy water, check for gas leakage from indoor unit's flare and outdoor unit's flare and valve rods. Close it after 5 seconds, and check for gas leakage.  
Wipe off all the water after completing the check.
- (7) Disconnect charging hose from gas service valve's service port and fully open liquid and gas service valves. (Do not attempt to turn valve rod beyond its stop.)
- (8) Tighten service valve caps and service port cap to the specified torque shown in the table below.

Service valve size (mm)	Service valve cap tightening torque (N·m)	Service port cap tightening torque (N·m)
ø6.35 (1/4")	20-30	10-12
ø9.52 (3/8")	25-35	
ø12.7 (1/2")		

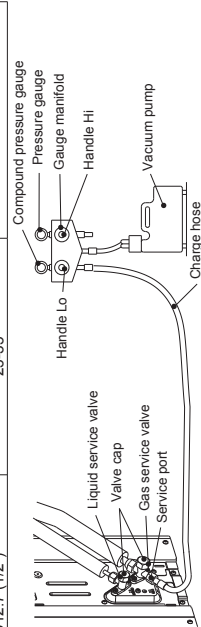

#### ⚠ CAUTION

To prevent vacuum pump oil from entering into the refrigerant system, use a counterflow prevention adapter.

## 8. INSTALLATION CHECK AND TEST RUN

After finishing the installation work, check the following points again before turning on the power. Conduct a test run and ensure that the unit operates properly.  
At the same time, explain to the customer how to use the unit and how to take care of the unit following the user's manual.

**NOTE**

During restart or change in operation mode, the unit will not start operating for approximately 3 minutes. This is to protect the unit and it is not malfunction.

**Before test run**

Before test run, check following points.

Power source voltage complies with the rated voltage of air-conditioner.	
Earth leakage breaker and circuit breaker are installed.	
Power cable and connecting cable are securely fixed to the terminal block.	
Both liquid and gas service valves are fully open.	
No gas leaks from the joints of the service valves.	
Indoor and outdoor side pipe joints have been insulated.	
Hole on the wall is completely sealed with putty.	
Drain hose and cap are installed properly.	
Screw of the lid is tightened securely.	

**Test run**

Check following points during test run.

Indoor unit receives signal of remote control.	
Air-conditioning operation is normal.	
There is no abnormal noise.	
Water drains out smoothly.	
Display of remote control is normal.	

**After test run**

Explain the operating and maintenance methods to the user according to the user's manual.  
Keep this installation manual together with user's manual.