

USER'S MANUAL

AIR-CONDITIONER

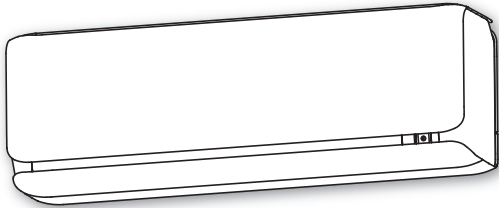

SRK20ZSX-WF
SRK25ZSX-WF
SRK35ZSX-WF
SRK50ZSX-WF
SRK60ZSX-WF



SRK20ZSX-WFB
SRK25ZSX-WFB
SRK35ZSX-WFB
SRK50ZSX-WFB
SRK60ZSX-WFB

SRK20ZSX-WFT
SRK25ZSX-WFT
SRK35ZSX-WFT
SRK50ZSX-WFT
SRK60ZSX-WFT

USER'S MANUAL
AIR-CONDITIONER

ENGLISH

MANUEL DE L'UTILISATEUR
CLIMATISEUR

FRANÇAIS

ANWENDERHANDBUCH
KLIMAGERÄT

DEUTSCH

ISTRUZIONI PER L'USO
CONDIZIONATORE D'ARIA

ITALIANO

MANUAL DEL PROPIETARIO
ACONDICIONADOR DE AIRE

ESPAÑOL

GEBRUIKERSHANDLEIDING
AIRCONDITIONING

NEDERLANDS

MANUAL DO UTILIZADOR
APARELHO DE AR CONDICIONADO

PORTUGUÊS

ΟΔΗΓΙΕΣ ΧΡΗΣΗΣ
ΚΛΙΜΑΤΙΣΤΙΚΟ

ΕΛΛΗΝΙΚΑ

РУКОВОДСТВО ПО ЭКСПЛУАТАЦИИ
КОНДИЦИОНЕР ВОЗДУХА

РУССКИЙ

KULLANIM KILAVUZU
SPLIT KLİMA

TÜRKÇE

Thank you for purchasing a MITSUBISHI HEAVY INDUSTRIES THERMAL SYSTEMS, LTD. Air-Conditioner. To get the best long-lasting performance, please read and follow this user's manual carefully before using your air-conditioner. After reading, please store the manual in a safe place and refer to it for operational questions or in the event of any irregularities.



Your air-conditioner is marked with this symbol. It means that waste electrical and electronic equipment (WEEE as in directive 2012/19/EU) should not be mixed with general household waste. Air-conditioner should be treated at an authorized treatment facility for re-use, recycling and recovery and not be disposed of in the municipal waste stream. Please contact the installer or local authority for more information.



This symbol printed on the batteries attached to your air-conditioner is information for end-users according to the EU directive 2006/66/EC article 20 annex II. Batteries, at their end-of-life, should be disposed of separately from general household waste. If a chemical symbol is printed beneath the symbol shown above, this chemical symbol means that the batteries contain a heavy metal at a certain concentration. This will be indicated as follows: Hg:mercury(0.0005%), Cd:cadmium(0.002%), Pb:lead(0.004%)
Please, dispose of batteries correctly at your local community waste collection or the recycling center.

ENGLISH



The emission sound pressure level from each Indoor and Outdoor unit is under 70 dB(A).

contents

<p>Safety precautions2</p> <p>Tips for effective operation7</p> <p>Name of each part and its function.....8</p> <p>Remote control10</p> <p>Operation failure with the remote control.....10</p> <p>Temporary run operation10</p> <p>Installing two air-conditioners in the same room..... 11</p> <p>Child lock.....11</p> <p>Airflow range setting12</p> <p>Operation and display section for remote control14</p> <p>Current time setting15</p> <p>AUTO mode operation.....15</p> <p>Temperature adjustment during AUTO mode ...16</p> <p>FAN SPEED16</p> <p>COOL/HEAT/DRY/FAN mode operation17</p> <p>Air-conditioner operation temperature range17</p> <p>Characteristics of HEAT mode operation.....17</p> <p>Airflow direction adjustment.....18</p> <p>3D AUTO operation18</p> <p>SLEEP TIMER operation19</p> <p>OFF TIMER operation19</p> <p>ON TIMER operation20</p>	<p>SLEEP TIMER + ON TIMER operation20</p> <p>ON TIMER + OFF TIMER operation21</p> <p>ALLERGEN CLEAR operation21</p> <p>WEEKLY TIMER operation22</p> <p>HIGH POWER/ECO operation26</p> <p>NIGHT SETBACK operation.....27</p> <p>SILENT operation27</p> <p>MENU function</p> <p style="padding-left: 20px;">Wireless LAN connection setting28</p> <p style="padding-left: 20px;">Display brightness adjustment.....28</p> <p style="padding-left: 20px;">AUTO OFF operation29</p> <p style="padding-left: 20px;">SELF CLEAN operation.....30</p> <p style="padding-left: 20px;">Fan control in heating thermo - OFF.....31</p> <p style="padding-left: 20px;">PRESET operation32</p> <p style="padding-left: 20px;">Wireless LAN communication setting33</p> <p style="padding-left: 20px;">Initialization of wireless LAN interface33</p> <p>Maintenance34</p> <p>Proper installation.....37</p> <p>Troubleshooting37</p> <p>Notice37</p> <p>Contact your dealer39</p> <p>Auto restart function39</p> <p>About the multiple air-conditioners39</p> <p>Self diagnosis function.....40</p>
---	---



Safety precautions



- Before starting to use the system, please read these “Safety precautions” carefully to ensure proper operation of the system.
- When you have read this user’s manual, please keep it safely. If someone else takes over as user, make sure that the manual is also passed on to the new user.

 WARNING	Indicates a potentially hazardous situation which, if not avoided, can result in serious consequences such as death or severe injury.
 CAUTION	Indicates a potentially hazardous situation which, if not avoided, can result in personal injury or property damage.

Please observe these precautions with great care, since they are essential to your safety.

- This unit is designed for 2 types refrigerants (R32 or R410A). See a label on the outdoor unit to check refrigerant information.
- Symbols which appear frequently in the text have the following meaning:

	Strictly prohibited		Observe instructions with great care		Provide proper earthing
---	----------------------------	---	---	---	--------------------------------

	The user’s manual should be read carefully.		A service personnel should be handing this equipment with reference to the installation manual.
	There is information included in the user’s manual and/or installation manual.		

■ Following precaution is only for R32.

	This equipment uses flammable refrigerants. If the refrigerant is leaked, together with an external ignition source, there is a possibility of ignition.
---	---

 WARNING	
<ul style="list-style-type: none"> • Strict compliance of the domestic laws must be observed when disposing the appliance. • Do not use means to accelerate the defrosting process or to clean, other than those recommended by the manufacturer. • The appliance shall be stored in a room without continuously operating ignition sources (for example: open flames, an operating gas appliance or an operating electric heater). • Do not pierce or burn. • Be aware that refrigerants may not contain an odour. 	<ul style="list-style-type: none"> • The appliance shall be stored in a well-ventilated area where the room size corresponds to the room area as specified for operation. • The staff in servicing operations must hold the national qualification or other relevant qualifications. • The indoor unit shall be stored in a room that has a minimum area of 4.0m².* <p>*This value is for split system. In the case of multi system, see the installation sheet of outdoor unit.</p>

■ Safety precautions

■ INSTALLATION PRECAUTIONS

⚠ WARNING



- **The system is for domestic and residential use.**

If used in severe environments, such as an engineering workplace, the equipment may function poorly.



- **The system must be installed by your dealer or a qualified installer.**

It is not advisable to install the system by yourself, as faulty handling may cause leakage of water, electric shock or fire.

⚠ CAUTION



- **Do not install it where flammable gas may leak.**

Gas leaks may cause fire.



- **Make sure that an earth leakage breaker is installed.**

If you do not install an earth leakage breaker, you may get an electric shock.

- **Make sure to install the drain hose properly so that all the water is drained out.**

Improper installation may lead to water drop in the room resulting in wet furniture.



- **Make sure that the system has been properly earthed.**

Earth wire should never be connected to a gas pipe, water pipe, lightning conductor or telephone earth wire. Improper installation of the earth wire may cause an electric shock.

This Product contains fluorinated greenhouse gases.

- Do not vent R32 into the atmosphere: R32 is a fluorinated greenhouse gas with a Global Warming Potential (GWP) = 675.
- Do not vent R410A into the atmosphere: R410A is a fluorinated greenhouse gas with a Global Warming Potential (GWP) = 2088.

Refer to a label on outdoor unit for the weight of fluorinated greenhouse gas and CO₂ equivalent.

■ Safety precautions

■ OPERATION PRECAUTIONS

⚠ WARNING



- **Children shall not play with the air-conditioner.**
- **Do not expose yourself to the cooling air for a long period.**
This could affect your physical condition and cause health problems.

- **Cleaning and user maintenance shall not be made by children without supervision.**
- **Do not insert anything into the air outlet.**
This may cause injury, as the internal fan rotates at high speed.



- **This air-conditioner can be used by children aged from 8 years and above and people with reduced physical, sensory or mental capabilities or lack of experience and knowledge, if they have been given supervision or instruction concerning use of the air-conditioner in a safe way and understand the hazards involved.**
- **Store the remote control out of reach of children.**
Failure to observe this may result in the batteries being swallowed or other accidents.

⚠ CAUTION



- **Only use approved fuses.**
Use of steel or copper wire instead of an approved fuse is strictly prohibited, as it may cause a breakdown or fire.
- **Do not handle the switches with wet hands.**
This may cause an electric shock.
- **Do not swing from the indoor unit.**
If the indoor unit falls down, you may get injured.
- **Do not place a flammable insecticide or paint spray near the air-conditioner, nor spray it directly on the system.**
This may result in a fire.
- **Do not expose any combustion appliance directly to the air stream of the air-conditioner.**
The combustion appliance may malfunction.
- **Do not wash the air-conditioner with water.**
This could cause an electric shock. Using a high pressure washer may cause damage to the aluminum fins, resulting in performance decrement.

- **Do not use for preservation of food, plants or animals, precision devices or works of art.**
The system is only intended for use in ordinary domestic rooms. Any other use of the system may damage the quality of food, etc.
- **Do not place anything containing water, like vases, on top of the unit.**
Water entering the unit could damage the insulation and therefore cause an electric shock.
- **Do not install the air-conditioner where the airflow direction is aimed directly at plants or animals.**
This will damage their health.
- **Do not step/sit on the unit nor put anything on it.**
If the unit falls down or things drop from it, people could get hurt.
- **After a long period of use, check the unit's support structure regularly.**
If you do not repair any damage right away, the unit may fall down and cause personal injury.

■ Safety precautions

⚠ CAUTION



- **Do not touch the aluminum fins on the heat exchanger.**

It may result in injury.

- **Do not place household electrical appliances or household items underneath the indoor or outdoor units.**

Condensation falling from the unit may stain objects and cause accidents or electrical shock.

- **Do not operate the system without the air filter.**

It can cause malfunction of the system due to clogging of the heat exchanger.

- **Do not shut off the power source immediately after stopping the operation.**

Wait at least 5 minutes, otherwise there is a risk of water leakage or breakdown.

- **Do not control the system with main power switch.**

It can cause fire or water leakage. In addition, the fan can start unexpectedly, which can cause personal injury.

- **Do not pour liquid into the unit and do not put water container on the unit.**

Water entering the unit could damage the insulation and therefore cause an electric shock.



- **If you operate air-conditioner together with a combustion appliance, you must regularly ventilate the indoor air.**

Insufficient ventilation may cause accidents due to oxygen deficiency.

- **Stand firmly on a stepladder or other stable object when removing the inlet panel and filters.**

Failure to observe this may result in injury through insecure objects toppling over.

- **When you clean air-conditioner, stop the unit and turn off the power source.**

Never open the panel while the internal fan is rotating.

- **Do not place objects near the outdoor unit or allow leaves to gather around the unit.**

If there are objects or leaves around the outdoor unit, small animals may enter unit and contact electrical parts and may cause a break-down, smoke or fire.

- **Contact your dealer to clean inside the indoor unit, do not attempt to do by yourself.**

The use of a non-approved detergent or improper washing method may damage the unit's plastic components and cause leaks. Damage, smoke, or fire may also happen if the detergent comes in contact with electrical parts or the unit's motor.

- **Stop the unit and turn off the power if you hear thunder or there is a danger of lightning.**

It may damage the unit.

- **If the power cable becomes damaged, contact your dealer or a qualified installer.**

If it is not replaced, it may cause a breakdown or fire.

■ Safety precautions

■ WIRELESS LAN PRECAUTIONS

WARNING



- **Do not turn ON the wireless LAN communication near automatic control equipment such as an automatic door or fire-alarm device.**
It may cause an accident due to malfunction of equipment.
- **Do not turn ON the wireless LAN communication in a hospital, etc. where the use of wireless devices is prohibited.**
It may cause malfunction of medical equipment due to a wireless device.
- **Do not turn ON the wireless LAN communication near a person with a cardiac pacemaker or implanted defibrillator.**
It may cause malfunction of a medical device.

CAUTION



- **Do not turn ON the wireless LAN communication near another wireless device, microwave, cordless phone, fax machine, etc.**
It may cause malfunction of wireless device.
- **When operating the air-conditioner from outdoors, fully confirm the statuses of the unit, its periphery, and persons in the room beforehand.**
It may cause damage to your health, contamination of household goods, or negative effects on animals.
- **When someone is in the room, notify him/her that the air-conditioner is to be operated from outdoors.**
It may cause damage to your health.



- **Check the operational status periodically.**
Sudden indoor/outdoor temperature changes may disturb your health.

■ Safety precautions

■ PRECAUTIONS FOR RELOCATION OR REPAIRS

WARNING



- **Do not perform any repairs or modifications by yourself. Consult the dealer if the unit requires repair.**

If you repair or modify the unit, it can cause water leaks, electric shocks or fire.



- **Consult your dealer for repairs.**
Wrong repairs could cause an electric shock, fire, etc.
- **In case the air-conditioner is relocated elsewhere, contact your dealer or a qualified installer.**
Faulty installation may cause water leakage, electric shock, fire, etc.
- **If you notice anything abnormal (smell of burning, etc.), stop the system, turn off the power source and consult your dealer.**

Continued use of the system in abnormal circumstances can result in malfunctioning, electric shock, fire, etc.

- **If the air-conditioner fails to cool or warm the room, it may have a refrigerant leakage. Contact your dealer.**

If refrigerant needs to be added, check with your dealer for proper instructions.

If the refrigerant comes in contact with the bare skin, it may cause cold injury.

If the refrigerant gas is inhaled excessively, it may cause deterioration of nerve function like dizziness and headache, or deterioration of heart function like irregular heartbeat and heart palpitation temporarily. If refrigerant unexpectedly leaks from the unit onto a fan heater, stove, hotplate or other heat source, harmful gases could be generated.

Tips for effective operation

■ Please observe the following for the most economic and comfortable use of your unit.

- **Set a suitable room temperature.**
Excessively high or low temperatures are not good for your health and waste of electricity.
- **Clean the filters frequently.**
Clogged filters may block the airflow and cause less efficient operation.  Page 34
- **Avoid direct sunlight and draught.**
Cut out direct sunlight by drawing the curtains or blinds when cooling. Keep windows and doors shut, except when ventilating.
- **Adjust the airflow direction properly.**
Adjust the up/down and left/right airflow to ensure a steady room temperature.
- **Operate the unit only when needed.**
Use the timer properly to operate the unit only when needed.
- **Keep heat source away when cooling.**
Keep heat sources out of the room as much as possible.

Name of each part and its function

INDOOR UNIT

Air inlet panel
 Page 34, 35

Air inlet

Room temperature sensor

Model name

Air filters
 Page 34

Fan
 • Inside of the unit

Heat exchanger (Aluminum fin)

Louvers (Vertical blades)
 • Left / right airflow direction adjustment

Flaps (Horizontal blades)
 • Up / down airflow direction adjustment

Air outlet

Motion sensor

QR code

- You can check the SSID and KEY (Password).

Unit display section
 Page 9



This equipment uses flammable refrigerant.
 Page 2

Air-cleaning filter

Page 36

- Allergen clear filter (Light orange)

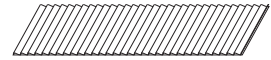

- Photocatalytic washable deodorizing filter (Orange)

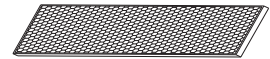

WARNING



Do not wash the inside of the air conditioner. Water leakage and permanent damage may result. Electrical hazard exists.



Caution, high voltage, shut off power before servicing fan and fan motor.

By the following operation, forced cooling operation is possible. Isolate the power supply. Reconnect power supply. Hold the ON/OFF switch down for 5 seconds until hear a beep.

OUTDOOR UNIT

Air inlet (back and side)

Fan
 • Inside of the unit

Heat exchanger (Aluminum fin)

Air outlet

Drain hole

Model name label (SRC50-60ZSX-W)

Model name and refrigerant type (SRC20-35ZSX-W)

Refrigerant pipe and electric wire

Drain hose

WARNING



MOVING FAN BLADES
 DO NOT INSERT ANYTHING INTO THE AIR OUTLET. IT MIGHT CAUSE INJURY.

CAUTION



SHARP EDGE OF FINS
 DO NOT TOUCH THE ALUMINUM FINS. IT MIGHT CAUSE INJURY.



DO NOT STEP ON TOP OF THIS UNIT. IT MIGHT CAUSE INJURY.



Don't touch the terminal block.



Don't touch refrigerant pipings and connections.



This equipment uses flammable refrigerant.

Page 2 (only R32 models)

Name of each part and its function

Unit display section

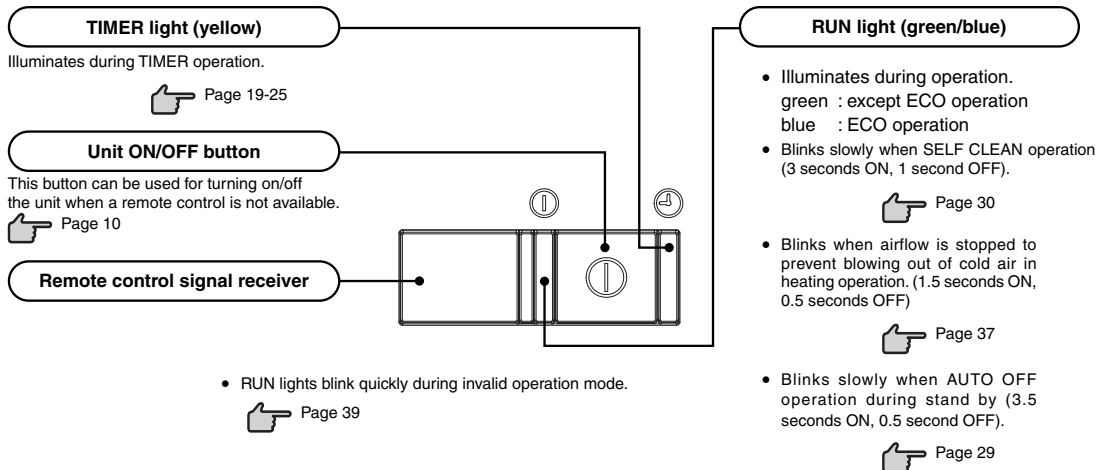

Accessories



Remote control



Remote control holder



Battery x 2
(R03 (AAA, Micro))



Wood screw x 2
(for remote control holder mounting)



Allergen clear filter
(Light orange)



Photocatalytic washable deodorizing filter (Orange)

⚠ CAUTION

- **Do not touch the air inlet panel and flap while it is operating.**
 - The air inlet panel opens up while the system is operating.
 - Do not install the unit in a fashion in which the air inlet panel cannot open or place objects near the indoor unit.
 - The air inlet panel and the flap close when the operation stops.
 - Your fingers may get caught when the panel or the flap closes.
- **Do not apply excessive force to the air inlet panel and flap. Doing so may cause these parts to malfunction.**

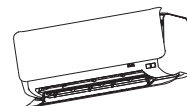

NOTE

• Buzzer sound for remote control

Buzzer sound (PipPip) is produced when

- preset temperature is set to 24 °C or,
- AUTO operation mode is selected or,
- automatic airflow is selected (except FAN mode operation).

Buzzer sound (Pip) is produced when

- air-conditioner is turned off by pressing ON/OFF button (except SELF CLEAN operation).

Buzzer sound (Peep Pip) is produced when

- Wireless LAN connection setting,
- Wireless LAN communication setting.

Airflow setting

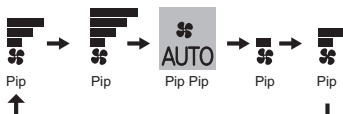

Preset temperature



Remote control

Setting the batteries

1 Pull out the cover.

2 Insert new batteries.
R03 (AAA, Micro) x 2

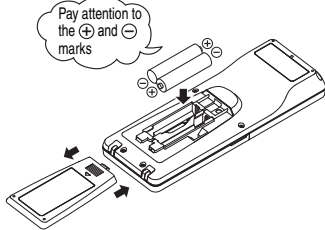

3 Close the cover.

4 Press the ACL switch with the tip of a ballpoint pen.

- Set the current time.

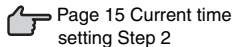

NOTE

- Do not use old and new batteries together.
- Remove the batteries when the remote control is not used for a long period.
- The recommended effective period of a battery conforming to JIS or IEC should be 6 to 12 months with normal use. If used longer, or when an unspecified battery is used, liquid may leak from the battery, causing the remote control to malfunction.
- The recommendable effective period is printed on the battery. This may be shorter due to manufacturing time to the unit. However, the battery may still be in working order after expiry of its nominal life.

- When the display shows any abnormal condition, press the ACL switch with the tip of a ballpoint pen.

Using the remote control holder

The remote control can be attached to a wall or pillar by using the remote control holder. Before installing the remote control, check that the air-conditioner receives the signals properly.

For installing or removing the remote control, move it up or down in the holder.

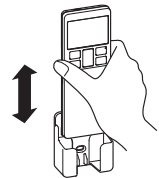

The following cases show exhausted batteries. Replace old batteries with new ones.

- Receiving beep is not emitted when a signal is transmitted.
- Display fades away.

Warning note for remote control

⊘ Strictly prohibited

- | | | |
|---|--|--|
| <ul style="list-style-type: none">• Do not take remote control near high temperature places, such as an electric heating carpet or a stove. | <ul style="list-style-type: none">• Do not leave the remote control exposed to direct sunlight or other strong lighting. | <ul style="list-style-type: none">• Do not drop the remote control. Handle with care. |
| <ul style="list-style-type: none">• Do not put any obstructing obstacles between the remote control and the unit. | <ul style="list-style-type: none">• Do not spill any liquid on the remote control. | <ul style="list-style-type: none">• Do not place heavy objects on the remote control, or step on it. |

Operation failure with the remote control

- Are the batteries running down?

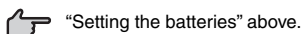

Replace the batteries with new ones and retry the operation.

- If the operation fails, operate the unit with temporary run operation function.

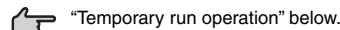

Contact your dealer to have the remote control checked.

Temporary run operation

- The unit ON/OFF button on the unit operates ON/OFF temporarily when the remote control is not used.

Operation program

- OPERATION MODE : AUTO
- FAN SPEED : AUTO
- AIR FLOW : AUTO

- Operation starts by pressing the unit ON/OFF button; it stops if you press the button again.



Unit ON/OFF button

NOTE

- Do not keep pressing the unit ON/OFF button down for 5 seconds or more.
(Pressing it 5 seconds or more sets the forced cooling operation used during servicing or when relocating the air-conditioner.)

Installing two air-conditioners in the same room

- When two air-conditioners are installed in the same room, use this setting when the two air-conditioners are not operated with one remote control. Set the remote control and indoor unit.

Setting the remote control

- Remove the cover and take out batteries.
- Disconnect the switching line next to the battery with wire cutters.

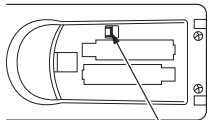

Disconnect

- Insert batteries. Close the cover.

Setting an indoor unit

- Turn off the power source and turn it on after 1 minute.
- Point the remote control (that was set according to the procedure described on the left side) at the indoor unit and send a signal by pressing the ACL switch on the remote control.

Since the signal is sent in about 6 seconds after the ACL switch is pressed, point the remote control at the indoor unit for some time.

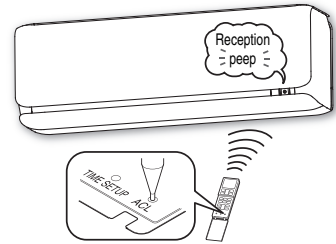

- Check that the reception buzzer sound "peep" is emitted from the indoor unit.

At completion of the setting, the indoor unit emits a buzzer sound "peep". (If no reception sound is emitted, start the setting from the beginning again.)

Child lock

- This function locks the remote control operation to prevent an operation error.

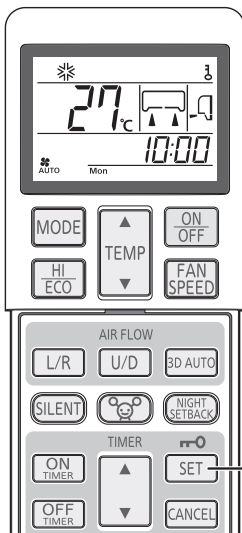

- Press the SET button for 3 seconds or more.

is displayed. When Child lock is set, only the ON/OFF button can be operated.

How to cancel

Turn off the light by pressing the SET button for 3 seconds or more.

NOTE

- While Child lock is set, the settings of operation mode, temperature, fan speed and airflow direction cannot be changed. To change the settings, reset Child lock.
- Child lock will not function during ALLERGEN CLEAR operation.

Airflow range setting

- Take the air-conditioner location into account and adjust the left/right airflow range to maximize air-conditioning.

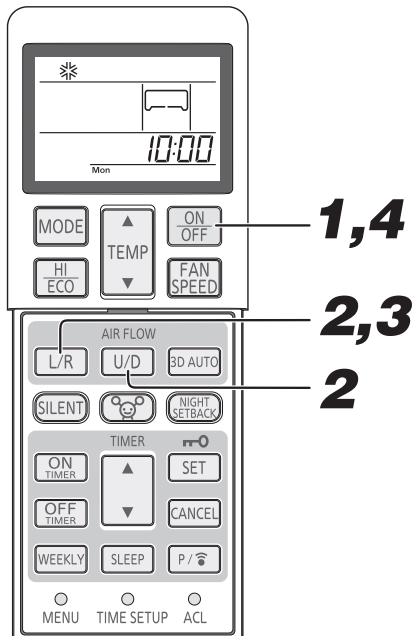

1 If the air-conditioner is running, press the ON/OFF button to stop.

The airflow range setting cannot be made while the unit is running.

2 Press the AIR FLOW U/D (UP/DOWN) button and the AIR FLOW L/R (LEFT/RIGHT) button together for 5 seconds or more.

The airflow range setting display illuminates.

3 Setting the airflow range.

Press the AIR FLOW L/R (LEFT/RIGHT) button and adjust to the desired location. Each time the AIR FLOW L/R (LEFT/RIGHT) button is pressed, the display is switched in the order of:



4 Press the ON/OFF button.

The air-conditioner's airflow range is set.

Press within 60 seconds of setting the airflow range (while the airflow range setting display illuminates).

Air-conditioner installation location and airflow range

The diagram below indicates the airflow ranges corresponding to the air-conditioner's installation location. Consider your room's layout and set the airflow range to maximize air-conditioning.

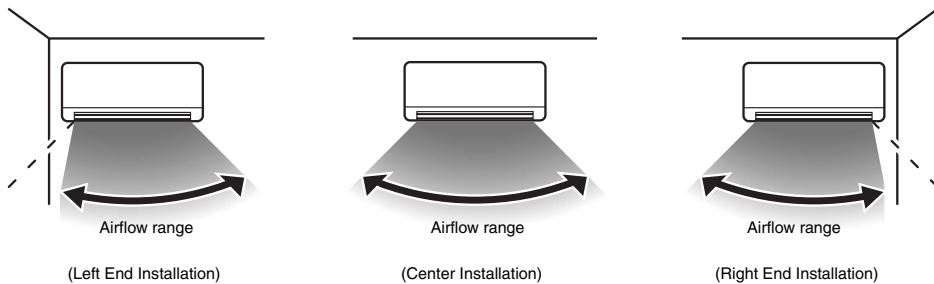

NOTE

- Once the airflow range setting is configured, it is stored in the air-conditioner even if the power source is turned off. To change the airflow range setting, set range again with the remote control.
- During the operation, an airflow range setting cannot be set.
- When the air-conditioner is installed at the location within 50 cm from the wall, it is recommended to change the airflow range setting to "Right End Installation" or "Left End Installation".

Motion sensor setting

- According to the installation location of the indoor unit, turn the sensor to the right or left until it clicks into position.
(The orientation of the application range can be changed laterally by approximately 20 degrees.)

	Left End Installation	Center Installation	Right End Installation
Air-conditioner installation location			
Motion sensor orientation	 Turn to the right	 Center	 Turn to the left

1 Open the air inlet panel.

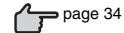

2 Change the orientation of the motion sensor.

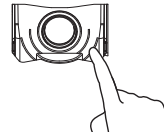

Adjust the orientation of the motion sensor by pressing the end of the sensor.

3 Close the air inlet panel.

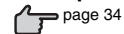

About the motion sensor

- The motion sensor detects the movement of people (heat-generating bodies) to determine whether there is someone in the room and how much they move.

The application range is as follows. Adjust the angle of the motion sensor according to the installation location of the indoor unit.

- Horizontal angle 100°(Top view)

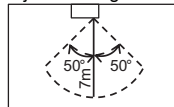

- Depending on the room conditions and/or the installation location, the motion sensor may not be able to detect people correctly. The motion sensor may not be able to detect people in the following cases:
 - When a person(s) is immediately under or beside the air-conditioner
 - When the room temperature is 30 °C or higher
 - When there is any obstacle such as furniture or a glass window between the air-conditioner and the person(s)
 - When the person(s) is covering most of their skin with extremely heavy clothes or they are exposing their backs to the air-conditioner
 - When the person(s) makes extremely little movement, which may occur while, for example, they are sleeping
- In the following cases, the motion sensor may judge that there is someone in the room even though there is actually not:
 - When there is an animal such as a dog or cat in the room
 - When plant leaves are swaying in the wind
 - When a heating appliance (e.g., oscillating heater) or other heat-generating object is moving
 - When there is a significant temperature change in walls or floors of the room at the time the operation starts

Operation and display section for remote control

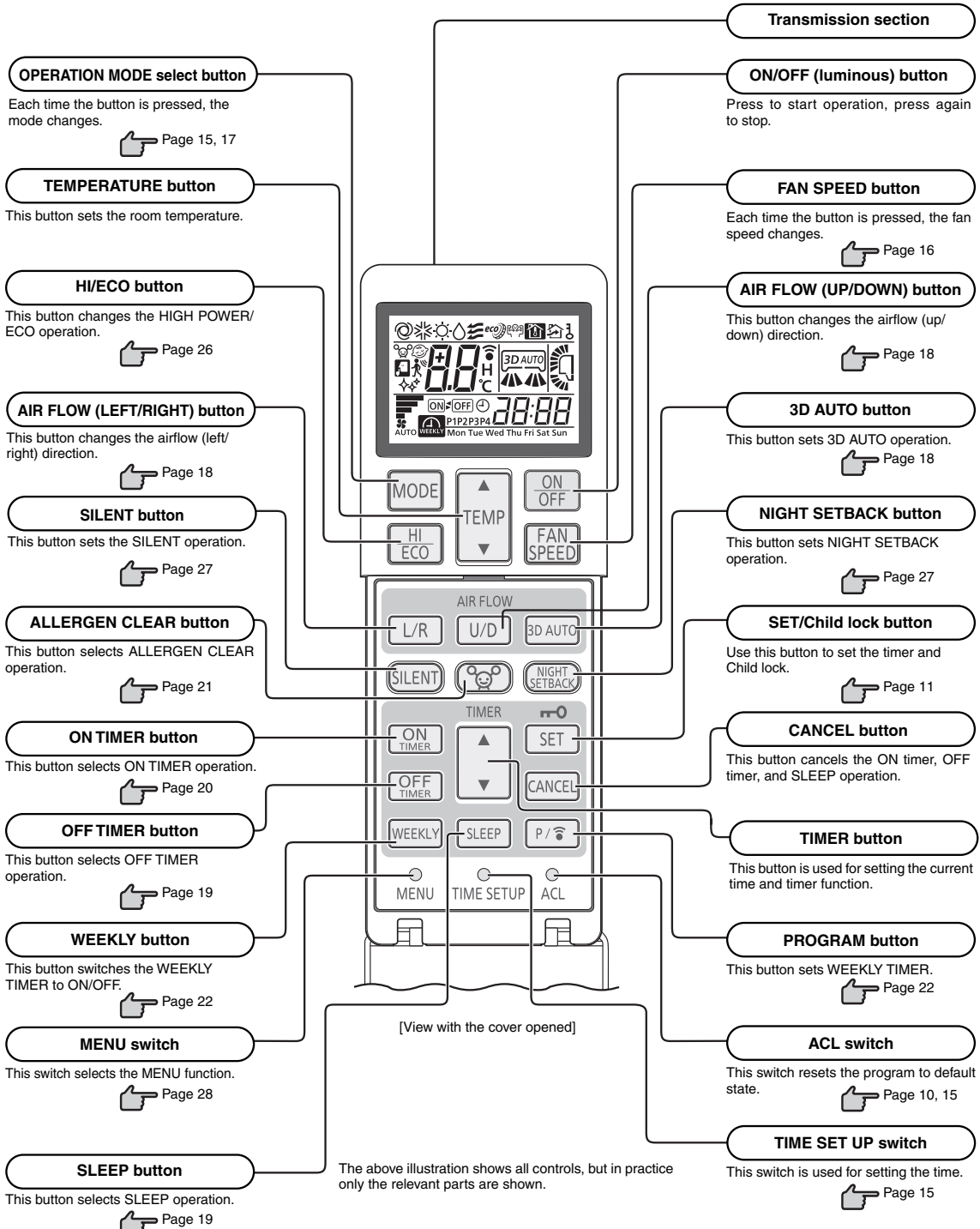

OPERATION MODE select button

Each time the button is pressed, the mode changes.
 Page 15, 17

TEMPERATURE button

This button sets the room temperature.

HI/ECO button

This button changes the HIGH POWER/ECO operation.
 Page 26

AIR FLOW (LEFT/RIGHT) button

This button changes the airflow (left/right) direction.
 Page 18

SILENT button

This button sets the SILENT operation.
 Page 27

ALLERGEN CLEAR button

This button selects ALLERGEN CLEAR operation.
 Page 21

ON TIMER button

This button selects ON TIMER operation.
 Page 20

OFF TIMER button

This button selects OFF TIMER operation.
 Page 19

WEEKLY button

This button switches the WEEKLY TIMER to ON/OFF.
 Page 22

MENU switch

This switch selects the MENU function.
 Page 28

SLEEP button

This button selects SLEEP operation.
 Page 19

Transmission section

ON/OFF (luminous) button

Press to start operation, press again to stop.

FAN SPEED button

Each time the button is pressed, the fan speed changes.
 Page 16

AIR FLOW (UP/DOWN) button

This button changes the airflow (up/down) direction.
 Page 18

3D AUTO button

This button sets 3D AUTO operation.
 Page 18

NIGHT SETBACK button

This button sets NIGHT SETBACK operation.
 Page 27

SET/Child lock button

Use this button to set the timer and Child lock.
 Page 11

CANCEL button

This button cancels the ON timer, OFF timer, and SLEEP operation.

TIMER button

This button is used for setting the current time and timer function.

PROGRAM button

This button sets WEEKLY TIMER.
 Page 22

ACL switch

This switch resets the program to default state.
 Page 10, 15

TIME SET UP switch

This switch is used for setting the time.
 Page 15

[View with the cover opened]

The above illustration shows all controls, but in practice only the relevant parts are shown.

Display in OFF status



The current time, day of the week, and present OPERATING MODE are displayed while the air-conditioner is turned off.

Transmission procedure

When each button on the remote control is pressed – with the remote control pointing towards the air-conditioner unit, a signal is transmitted. When the air-conditioner receives the signal correctly, it will beep.

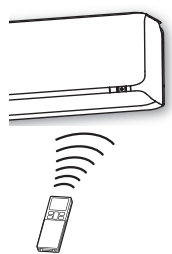

Current time setting

- When inserting the batteries, the current time is automatically set to time setting mode. Mon and 13:00 are displayed as the current time. Set a correct day of the week and time.

Example: Set to Sat 10:30.

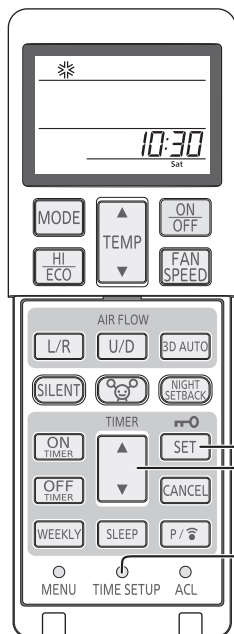

1

Press the TIME SET UP switch.

Press with the tip of a ballpoint pen, etc.
The day of the week display blinks, enabling the setting of a day of the week.

2

Press the “▲ or ▼ (TIMER)” button.

(Set to Sat)

3

Press the SET button.

The day of the week display changes from blinking to steady lighting, completing the setting of a day of the week, and the time display blinks. Make sure to press the button within 60 seconds from the last operation in step 2, otherwise the day of the week will not be set.

4

Press the “▲ or ▼ (TIMER)” button.

(Set to 10:30)

5

Press the SET button.

The time display changes from blinking to steady lighting and the setting is complete. Make sure to press the button within 60 seconds from the last operation in step 4, otherwise the time will not be set.

NOTE

- The timer operation works based on the time clock, so set it correctly.
- The remote control data will be reset when the present time is set.
- When the battery of the remote control is replaced or the ACL switch is pressed, the remote control will be set to the initial state. Since the WEEKLY TIMER program is not set in the initial state, set the program according to the setting procedure.

AUTO mode operation

- Automatically selects the operation mode (COOL, HEAT) depending on the room temperature when switched on.

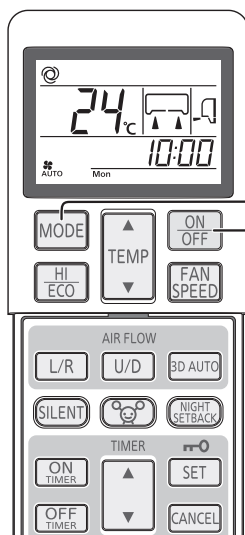

1

Press the MODE button.

The mode changes whenever the button is pressed.
Set to ☉.

2

Press the ON/OFF button.

To stop:

Press the ON/OFF button.

NOTE

- In case air is not blowing out during the operation.

➡ Page 37

- If you do not want the AUTO mode program, change to COOL, HEAT or FAN instead of AUTO.

➡ Page 17

- Airflow direction adjustment procedure.

➡ Page 18

Temperature adjustment during AUTO mode

- Default preset temperature during AUTO mode is 24 °C for both cooling and heating mode. However, it can be adjusted (Minimum 18 °C, Maximum 30 °C) using ▲ button or ▼ button.

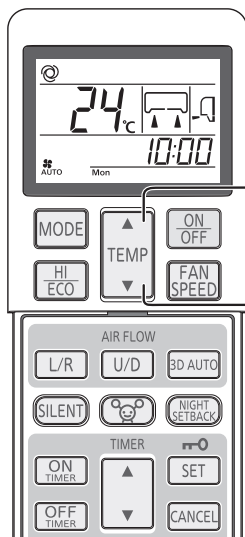

1 Press the “▲ or ▼ (TEMP)” button.

When it is a little cold
Press the ▲ button.

- Each time the ▲ button is pressed, the switch over occurs in the following order 18 → 19 → 23 → 24 → 25 → 30.

When 30 is indicated, even if the ▲ button is pressed, the indicator does not change.

When it is a little hot
Press the ▼ button.

- Each time the ▼ button is pressed, the switch over occurs in the following order 30 → 29 → 25 → 24 → 23 → 18.

When 18 is indicated, even if the ▼ button is pressed, the indicator does not change.

FAN SPEED

- The FAN SPEED can be set except for DRY mode.

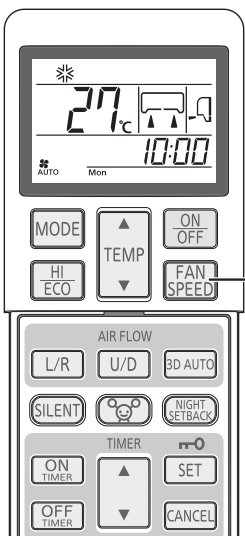

1 Press the FAN SPEED button.

Each time the button is pressed, the fan speed changes.

Operation capacity by your choice	FAN SPEED
Set automatically by microcomputer	AUTO
Silent operation	ULo
Energy-saving operation	Lo
Standard operation	Me
Powerful operation with high capacity	Hi

NOTE

- When FAN SPEED is changed from Hi to Lo or ULo, the sound of refrigerant may be heard.
- When COOL mode is used if outside temperatures are low, the FAN SPEED may change automatically to protect the air-conditioner.

COOL/HEAT/DRY/FAN mode operation

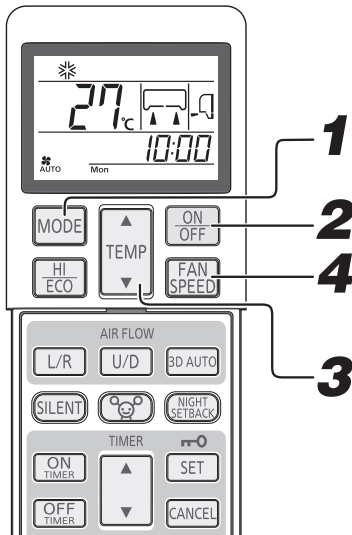

Airflow direction adjustment procedure. Page 18

NOTE

- In case air is not blown out, when starting the heating operation. Page 37
- The operation mode can also be set or changed when the air-conditioner is not in operation.

1

Press the MODE button.

Set to a required mode.

☀ (COOL), ☀ (HEAT), ☀ (DRY), ☀ (FAN)

2

Press the ON/OFF button.

3

Press the TEMP button.

Press ▲ or ▼ button for the preferred temperature.

Recommendation

COOL	HEAT	DRY	FAN
26 °C - 28 °C	22 °C - 24 °C	24 °C - 26 °C	—

4

Press the FAN SPEED button

Set the fan speed as preferred.

A fan speed cannot be set under DRY operation.

To stop:

Press the ON/OFF button.

Air-conditioner operation temperature range

- Use within the following operational range. Operating outside of this range may result in the protection devices being activated and preventing the unit from working.

	COOL mode operation	HEAT mode operation
Outside temperature	Approximately -15 to 46 °C	Approximately -20 to 24 °C
Inside temperature	Approximately 18 to 32 °C	Approximately 10 to 30 °C
Inside humidity	Below approximately 80 % The long-term use of the unit with a humidity level exceeding 80 % may result in condensation forming on the surface of the indoor unit, leading to water drops.	

Characteristics of HEAT mode operation

Mechanism and capacity of HEAT mode operation

- The unit draws heat from the cold outside air, transfers it to indoors and heats the room. As a characteristic of heat pump system, the heating capacity reduces when the outside air temperature gets colder.
- It may take some time to supply hot air after turning on the air-conditioner.
- If the outside temperature becomes extremely low, it would be better to use an additional source of heating.

Defrosting

If the outside temperature becomes low and humidity is high, the heat exchanger in the outdoor unit may frost over, which prevents efficient heating.

If this happens, the automatic defrost function is activated and the heating operation stops for 5 to 15 minutes during defrosting.

- Both indoor and outdoor fans stop and the RUN light blinks slowly (1.5 seconds ON, 0.5 seconds OFF) during defrosting.
- The outdoor unit may release some steam during defrosting. This is to help the defrosting process and is not a defect.
- The HEAT operation resumes as soon as defrosting has been completed.

Airflow direction adjustment

- Up/down direction can be adjusted with the AIR FLOW U/D (UP/DOWN) button on the remote control. Every time you press this button, the mode changes as follows:

Change on AIR FLOW (UP/DOWN) mode.

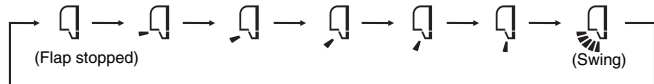

- Left/right direction can be adjusted with the AIR FLOW L/R (LEFT/RIGHT) button on the remote control. Every time you press this button, the mode changes as follows:

Change on AIR FLOW (LEFT/RIGHT) mode.

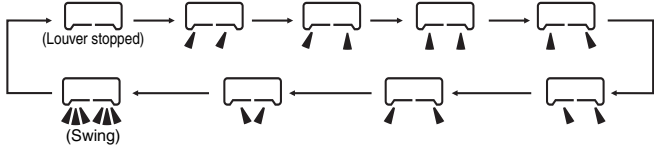

NOTE

- The actual position of the flap and louver may differ from the display shown.

NOTE FOR HEATING OPERATION

- When heating operation starts, the flap and louver direction is fixed at the horizontal / center position in order to avoid cold draft. It returns to the set position when the warm air supply is started.
- The flap and louver direction will be controlled to the horizontal/center position when the room temperature reaches the set temperature and compressor stops or when defrosting is in operation.
- The airflow direction cannot be set during the period mentioned above. Change the airflow direction settings after the warm air is supplied and the flap/louver goes to the set position.

Memory flap (Flap or louver stopped)

When you press the AIR FLOW (U/D or L/R) button once while the flap or louver is operating, it stops swinging at the position. Since this angle is memorized in the microcomputer, the flap or louver will automatically be set at this angle when the next operation is started.

- WARNING**
Do not expose directly to airflow from the air-conditioner for a long time.

- CAUTION**
When in COOL or DRY operation, do not operate for a long period with the airflow blowing straight down. Otherwise, condensation may appear on the outlet grill and drip down.
- Do not try to adjust the flaps and louvers by hand, as the control angle may change or the flap or louver may not be closed completely.

- Recommended angle of the flap when stopping

HEAT		(Slant forward blowing)
COOL, DRY		(Horizontal blowing)

3D AUTO operation

- Fan speed and airflow direction are automatically controlled, allowing the entire room to be efficiently air-conditioned. When the air-conditioner is turned off, start the operation from Step 1. When the air-conditioner is running, start from Step 2.

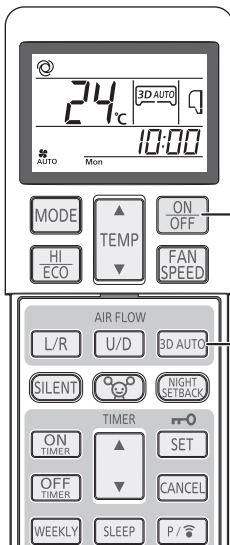

1

Press the ON/OFF button.

2

Press the 3D AUTO button.

Each time the 3D AUTO button is pressed, the display is switched in the order of:

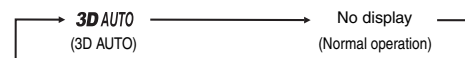

How to cancel

Press the 3D AUTO button to turn off the 3D AUTO display.

NOTE

- 3D AUTO operation is canceled when you switch the operation mode.
- If 3D AUTO operation is canceled then the airflow direction changes to that used before 3D AUTO was set.
- 3D AUTO operation can be set in AUTO, COOL, or HEAT operation mode only.

SLEEP TIMER operation

- The unit will stop automatically after the set time lapses.

The set temperature is automatically adjusted according to the lapse time in order to avoid too much cooling or heating.  Page 21

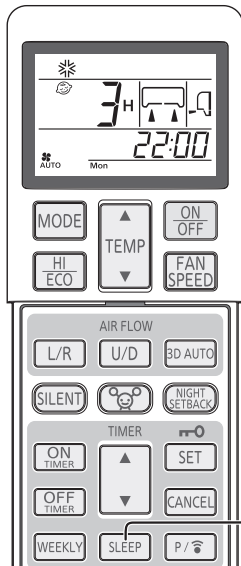

Changing of set time

Set a new time by pressing SLEEP button.

How to cancel

Press the CANCEL button to turn off the SLEEP display.

1

Press the SLEEP button.

- If it is pressed while the unit is off

SLEEP TIMER operation starts with the previous operation settings, and the air-conditioner is turned off after the set time lapses.

- If it is pressed while the unit is running

The air-conditioner is turned off after the set time lapses.

Every time the button is pressed, the display changes as follows:

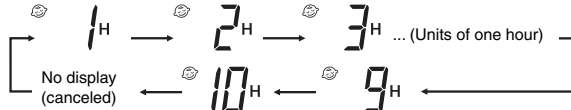

Example: You prefer it to stop after 3 hours.

Set to 3H

The timer light (yellow) is on.

- The unit stops after the set time lapses.

NOTE

- SLEEP operation will not function during ALLERGEN CLEAR operation.
- SLEEP TIMER cannot be set simultaneously with OFF TIMER.

OFF TIMER operation

- The unit stops automatically when the set time comes.

When the air-conditioner is turned off, start the operation from Step 1. When the air-conditioner is running, start from Step 2.

Example: You prefer it to stop 22:30.

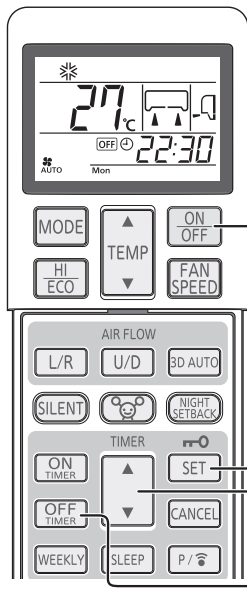

Changing of set time

Set a new time by using the OFF TIMER button.

How to cancel

Press the CANCEL button to turn off the timer display.

1

Press the ON/OFF button.

2

Press the OFF TIMER button.

OFF TIMER display OFF is blinking.

3

Press the “▲ or ▼ (TIMER)” button.

Every time the ▲ button is pressed, the display is switched in the order of:

→0:00→0:10→0:20→...→1:00→1:10→ (Units of ten minutes)

Every time the ▼ button is pressed, the display is switched in the order of:

→0:00→23:50→23:40→...→23:00→22:50→ (Units of ten minutes)

Set at 22:30.

4

Press the SET button.

The display changes from blinking to steady lighting and the setting is complete.

The timer light (yellow) is on.

NOTE

- The unit stops at the end of the set period of time.
- Make sure to press the button within 60 seconds from the last operation in step 3, otherwise the setting is not completed.
- The current time is not displayed during OFF TIMER operation.
- OFF TIMER operation will not function during ALLERGEN CLEAR operation.
- Different from SLEEP TIMER operation, automatic set temperature adjustment is not done during OFF TIMER operation.

ON TIMER operation

- Operation starts 5 to 60 minutes before the set time so that the room temperature reaches the optimum temperature at the set time.  Page 21
ON TIMER operation can be set regardless of whether the air-conditioner is running or not.

Example: When the preferred room temperature is required at 8:00.

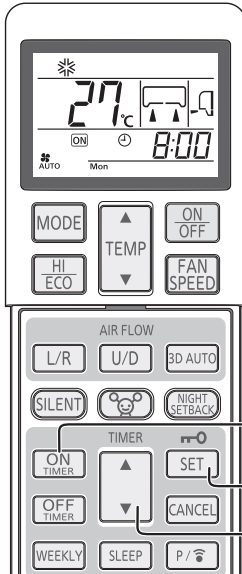

1 Press the ON TIMER button.

ON TIMER display  is blinking.

2 Press the “▲ or ▼ (TIMER)” button.

Every time the ▲ button is pressed, the display is switched in the order of:

0:00 → 0:10 → 0:20 → ... → 1:00 → 1:10 → (Units of ten minutes)

Every time the ▼ button is pressed, the display is switched in the order of:

0:00 → 23:50 → 23:40 → ... → 23:00 → 22:50 → (Units of ten minutes)

Set at 8:00.

3 Press the SET button.

The display changes from blinking to steady lighting and the setting is complete.

The timer light (yellow) is on.

If ON TIMER setting is performed when air-conditioner is running, air-conditioner operation will stop.

NOTE

- Operation starts 5 to 60 minutes before the set time.
- The timer light (yellow) goes out at the set time.
- Make sure to press the button within 60 seconds from the last operation in step 2, otherwise the setting is not completed.
- The current time is not displayed during ON TIMER operation.
- ON TIMER operation will not function during ALLERGEN CLEAR operation.
- If the ON/OFF button is pressed after setting the ON TIMER, the setting will be canceled.

Changing of set time

Set a new time by using the ON TIMER button.

How to cancel

Press the CANCEL button to turn off the timer display.

SLEEP TIMER + ON TIMER operation

- This is the combined timer operation of SLEEP TIMER and ON TIMER.

Example: When it is required to stop after 3 hours and then start operation at 8:00, near the set temperature.

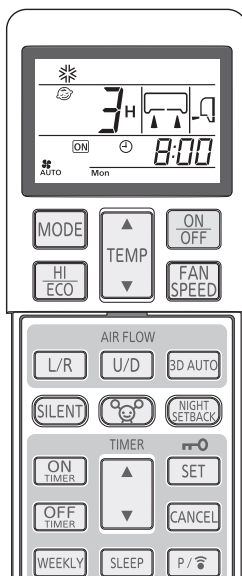

1 SLEEP TIMER setting

Set by the procedures on page 19.

Set to  3H

2 ON TIMER operation setting

Set by the above procedure mentioned in ON TIMER.

Set to  8:00

The setting of the lighting of the timer light (yellow) of this unit is complete.



- After the SLEEP TIMER set time has lapsed, the operation stops, and it starts from 5 to 60 minutes before the ON TIMER's set time.
- The timer light is turned off when ON TIMER set time comes.

Changing of set time

Set a new time by using the SLEEP or ON TIMER button.

How to cancel

Press the CANCEL button to turn off the timer display.

ON TIMER + OFF TIMER operation

■ This is the combined timer operation of ON TIMER and OFF TIMER.

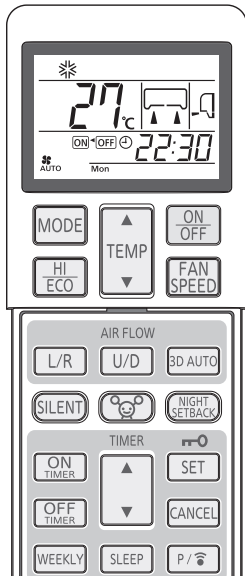

Example: Present time is 21:00. The air-conditioner running.

When it is preferred to stop at 22:30, and then start operation at 8:00, near the set temperature.

1 OFF TIMER operation setting

Set by the procedures on page 19.

Set to OFF 22:30

2 ON TIMER operation setting

Set by the procedures on page 20.

Set to ON/OFF 8:00

Timer light (yellow) on the unit will light when the setting is completed.

■ The set time will be displayed on the remote control. The display will change depending on the operational status.

- The air-conditioner stopping.
 → → First the air-conditioner starts running with ON TIMER. After the air-conditioner stops running with OFF TIMER.
- The air-conditioner running.
 ← → First the air-conditioner stops running with OFF TIMER. After the air-conditioner starts running with ON TIMER.

Changing of set time

Set a new time by using the OFF TIMER or ON TIMER button.

How to cancel

Press the CANCEL or ON/OFF button to turn off the timer display.

NOTE

- Timer operation can be set only for next 24 hours.

Comfort Start-up

In ON TIMER operation, the unit starts the operation a little earlier, so that the room can approach optimum temperature at ON time. This is called "Comfort start-up".

• Mechanism

The room temperature is checked 60 minutes before the ON time. Depending on the temperature at that time, the operation starts 5 to 60 minutes before the timer is at ON.

• The function is available for COOL, HEAT and DRY operation mode (including AUTO).

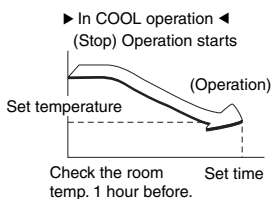

SLEEP TIMER

When SLEEP TIMER is selected, the set temperature is automatically adjusted after a while, ensuring that the room is not too cold during cooling or too warm during heating.

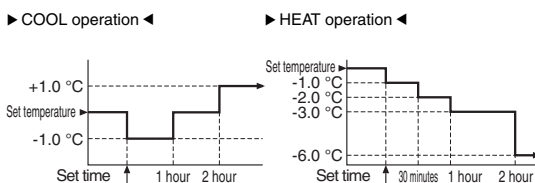

ALLERGEN CLEAR operation

■ The power of enzymes is used to eliminate allergy-causing allergens that accumulate on the allergen clear filter.

1

Press the ALLERGEN CLEAR button.

To stop:

Press the ON/OFF or ALLERGEN CLEAR button.

NOTE

- Since the room temperature may change quite a bit, it is recommended that this be used when no one is in the room. (It completes automatically in approximately 90 minutes.)
- During ALLERGEN CLEAR operation temperature, fan speed, airflow direction and timer operations settings cannot be made.
- In case of SCM multi system, ALLERGEN CLEAR control function is invalid.
- In case of SCM multi system, if ALLERGEN button is pressed by mistake, the indoor unit which received such command will stop.

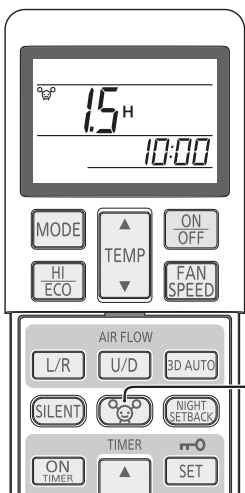









WEEKLY TIMER operation

- Up to 4 programs with timer operation (ON TIMER / OFF TIMER) are available for each day of the week. Maximum 28 programs per week are available. Once this has been set, the timer operation will be repeated at the same programs every week unless the WEEKLY TIMER is canceled.

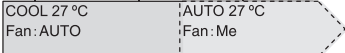
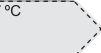
Sample (At cooling season)

 : WEEKLY TIMER setting

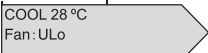
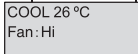
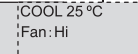
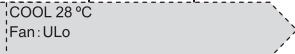
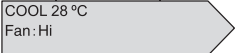
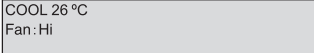
 : MANUAL setting

	6:00	8:00	10:00	12:00	14:00	16:00	18:00	20:00	22:00
Mon	Program 1 ON 6:00	Program 2 OFF 8:30				Program 3 ON 17:00			Program 4 OFF 22:00
									
Tue	Program 1 ON 5:30	Change setting	Program 2 OFF 12:00	ON		Program 3 ON 17:00			Program 4 OFF 22:00
									
Wed ~ Fri		ON	Program 1 OFF 10:00	ON	Program 2 OFF 14:00	Program 3 ON 18:00			Program 4 OFF 22:00
									
Sat		Program 1 ON 7:30	Change setting	Program 2,3 No setting		Change setting			Program 4 OFF 22:00
									
Sun		Program 2 ON 7:00	OFF	Program 1 ON 12:00		Program 3 ON 19:00			Program 4 OFF 22:00
									

WEEKLY TIMER ON/OFF setting

- Switch the WEEKLY TIMER to ON/OFF by using the WEEKLY button.

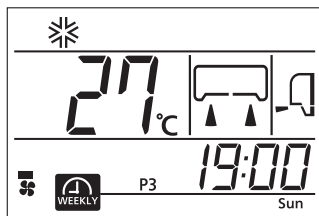

1

Press the WEEKLY button.

The WEEKLY TIMER becomes effective.

Every time the WEEKLY button is pressed, the display is switched in the order of:

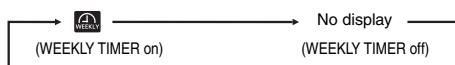

When the WEEKLY TIMER is set to ON, the timer light (yellow) of the air-conditioner is on.

When the battery of the remote control is replaced or the ACL switch is pressed, the remote control is set to the initial state. Since the WEEKLY TIMER program is not set in the initial state, set the program according to the setting procedure.

NOTE

- The WEEKLY TIMER is switched to ON/OFF regardless of whether the air-conditioner is running or not.
- The ON TIMER operation of the WEEKLY TIMER is effective regardless of whether the air-conditioner is running or not. When the ON TIMER setting time is reached, the remote control operates according to the contents that are set. The remote control display is also switched to the operation contents that are set. The setting can be changed from the remote control after ON TIMER operation of the WEEKLY TIMER. The following contents can be set by the ON TIMER. Operation mode, fan speed, temperature, airflow direction, ECO, 3D AUTO, NIGHT SETBACK, SILENT. Comfort start-up is not performed for WEEKLY TIMER ON TIMER operation.
- OFF TIMER operation of the WEEKLY TIMER is effective only when the air-conditioner is running. When the time set by the OFF TIMER is reached, the air-conditioner stops.
- When multiple program numbers are set for the current day (day of the week), the operation is performed from the earliest time that is set.
- If any timer operation (ON TIMER, OFF TIMER or SLEEP TIMER) in addition to the WEEKLY TIMER operation is set, operation will not start according to the ON TIMER/OFF TIMER settings specified with the WEEKLY TIMER operation. After canceling all other timer operations (ON TIMER, OFF TIMER and SLEEP TIMER), switch on the WEEKLY TIMER operation.
- The ON TIMER or OFF TIMER of the same time in the same day of the week cannot be set.
- In case WEEKLY TIMER setting is not sent to the unit, TIMER light will not turn on even if the WEEKLY button is pressed and  is displayed on the remote control.

Setting mode <Individual setting>

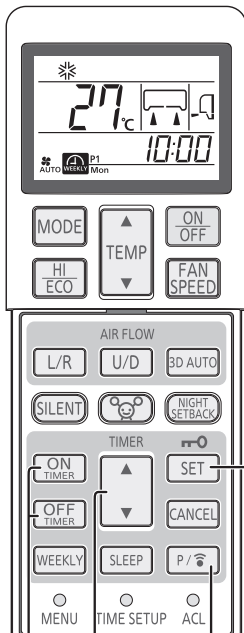

6

2,4

1

3,5

Set after setting the current day of the week and the time.

1

Press the PROGRAM button.

and current day of the week blink.

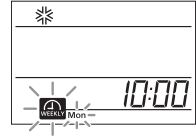

2

Press the “▲ or ▼ (TIMER)” button.

Select a day of the week to be reserved.
Every time the ▲ button is pressed, the display is switched in the order of:

→ Mon → Tue → Wed → ... → Sun → Display of all of the days of the week

Every time the ▼ button is pressed, the display is switched in the order of:

→ Mon → Display of all of the days of the week → Sun → Sat → ... → Tue



3

Press the SET button.

The day of the week is determined and the program number blinks.

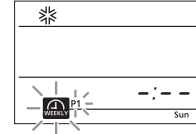

4

Press the “▲ or ▼ (TIMER)” button.

Select a program number.

Every time the ▲ button is pressed, the display is switched in the order of:

→ P1 → P2 → P3 → P4

Every time the ▼ button is pressed, the display is switched in the order of:

→ P1 → P4 → P3 → P2

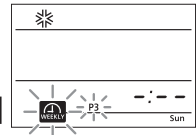

5

Press the SET button.

When no set contents (ON TIMER or OFF TIMER) are available, both the and timers blink.

When set contents (ON TIMER or OFF TIMER) are available, either or timer blinks.

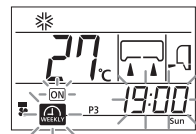
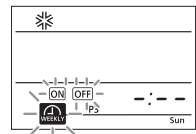

6

Press the ON TIMER or OFF TIMER button.

ON TIMER or OFF TIMER is determined and time display blinks.

ON TIMER is selected

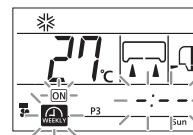

OFF TIMER is selected

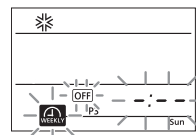

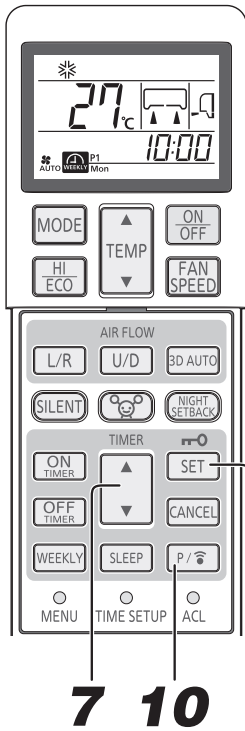

7 10
8,9,10

7

Press the “▲ or ▼ (TIMER)” button.

Set a time.

Every time the ▲ button is pressed, the display is switched in the order of:

→0:00→0:10→0:20→...→1:00→1:10→(Units of ten minutes)

Every time the ▼ button is pressed, the display is switched in the order of:

→0:00→23:50→23:40→...→23:00→22:50→(Units of ten minutes)

When ON TIMER is selected, go to Step 8.
When OFF TIMER is selected, go to Step 9.



8

Set operation contents.

When ON TIMER is selected, operation mode, fan speed, and airflow direction can be changed and the ECO, SILENT or NIGHT SETBACK operation can be set.

9

Press the SET button.

The time and operation contents are determined and and blink.

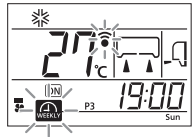

10

< To apply settings >
Point the remote control towards the remote control signal receiver of the indoor unit.

Press the PROGRAM button.

Settings are sent to the air-conditioner.
Point the remote control towards the remote control signal receiver of the indoor unit, press the PROGRAM button, and then wait 3 seconds.
After 3 seconds, the settings are sent to the air-conditioner, which emits a reception buzzer sound three times (pip, pip, pip). If the buzzer sound is not emitted, press the PROGRAM button again to send the settings.

< To continue making settings >

Press the SET button.

Continue from Step 2 to make settings for other programs.

Setting mode <Collective setting>

- Set the same operation contents to the same program number of all the days of the week. In Step 2 above, select “all of the days of the week”. When the contents that were individually set exist in the same program number, the contents are overwritten.

NOTE

- If no operation is performed for 60 seconds in setting mode, the setting changes that have been made until then become invalid and the setting mode terminates. Subsequently, and all the program numbers (P1, P2, P3 and P4) blink for 10 seconds. (This blinking can not be observed if setting mode gets terminated while setting only one program.)
- At the end of the setting mode, point the remote control at the air-conditioner and press the PROGRAM button. In this case, check that the air-conditioner emits a reception buzzer sound three times (pip, pip, pip). If the buzzer sound is not emitted, set the mode to the setting mode again by pressing the PROGRAM button and check that the buzzer sound is emitted.

How to cancel the setting <Individual setting>

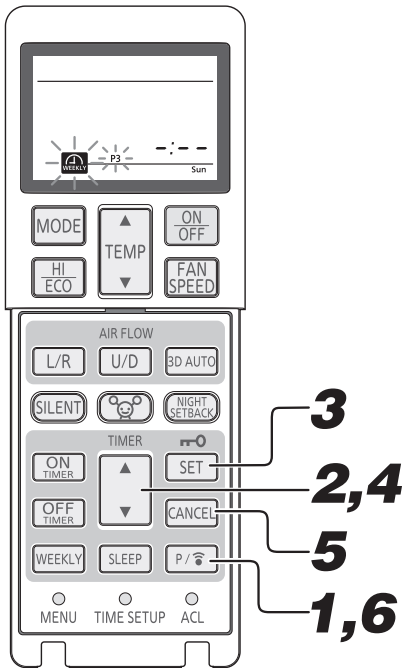

1 Press the PROGRAM button.

and current day of the week blink.

2 Press the “▲ or ▼ (TIMER)” button.
Select a day of the week to be canceled.

3 Press the SET button.
The day of the week is determined and the program number blinks.

4 Press the “▲ or ▼ (TIMER)” button.
Select a program number to be canceled.

At cancellation operation, do not press the SET button. If the SET button is pressed, the mode is shifted to the Set mode.

5 Press the CANCEL button.
The setting contents of the ON or OFF TIMER are canceled and --:-- is displayed on the time display section.

6 Point the remote control towards the remote control signal receiver of the indoor unit.

Press the PROGRAM button.

When the PROGRAM button is pressed, the setting is sent to the air-conditioner. When the setting is received, a buzzer sound (pip, pip, pip) is emitted. The setting contents of each program are canceled. Perform the operation indicated above for each program to be canceled.

How to cancel the setting <Collective setting>

- When the same operation contents exist in the same program number of all the days of the week, collective erase is allowed. In Step 2 above, select “all of the days of the week”. The procedure from Step 3 is the same as that indicated above. If the operation contents have been changed or erased by individual setting after the collective setting described in page 24, causing setting content discrepancies among the days of the week, collective erase is not allowed.

Confirm mode

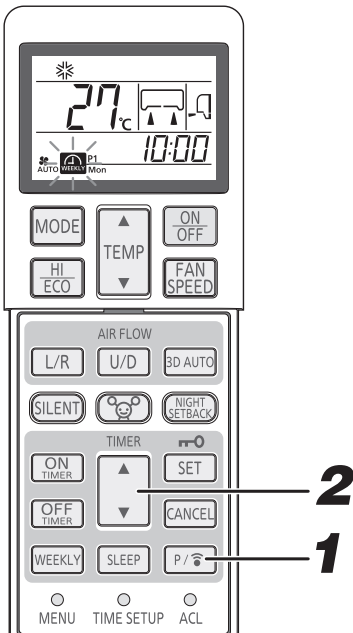

The WEEKLY TIMER setting contents can be confirmed.

1 Press the PROGRAM button for 3 seconds or more.

blinks and the setting content lights.

2 Press the “▲ or ▼ (TIMER)” button.
Select a day of the week and a program number to be confirmed.

Display starts from the current day of the week. For the program without setting, --:-- is displayed. When the PROGRAM button is pressed in Confirm mode, a setting mode is set.

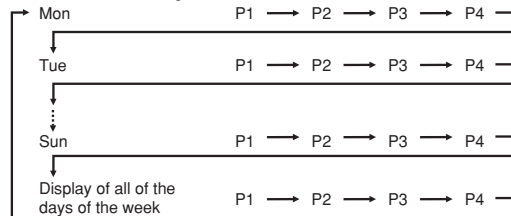

How to cancel

The Confirm mode can be terminated by pressing the ON/OFF, CANCEL or SET button.

NOTE

- If no operation is performed for 60 seconds in Confirm mode, the Confirm mode is terminated.

HIGH POWER/ECO operation

■ When the air-conditioner is turned off, start the operation from Step 1. When the air-conditioner is running, start from Step 2.

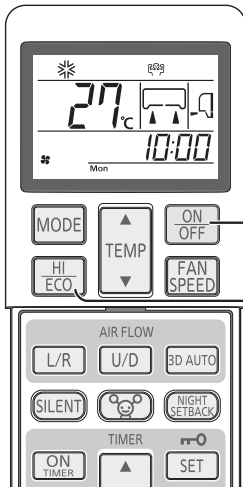

1 Press the ON/OFF button.

2 Press the HI/ECO button.

- When the operating mode is AUTO, COOL or HEAT
Every time the HI/ECO button is pressed, the display is switched in the order of:



- When the operating mode is DRY or ON TIMER + OFF TIMER
Every time the HI/ECO button is pressed, the display is switched in the order of:

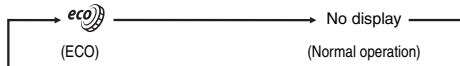

HIGH POWER operation

Pressing the HI/ECO button intensifies the operating power and initiates powerful cooling or heating operation for 15 minutes continuously. The remote control displays and the FAN SPEED display is disappeared.

NOTE

- During the HIGH POWER operation, the room temperature is not controlled. When it causes an excessive cooling or heating, press the HI/ECO button again to cancel the HIGH POWER operation.
- HIGH POWER operation is not available during the DRY and ON TIMER + OFF TIMER operations.
- When HIGH POWER operation is set after setting ON TIMER operation, HIGH POWER operation will start from the set time.
- After HIGH POWER operation, the sound of refrigerant flowing may be heard.
- When the following operations are set, HIGH POWER operation will be canceled.
 - When the HI/ECO button is pressed again. (The operation mode will be changed to the ECO operation)
 - When the operation mode is changed.
 - When it has been 15 minutes since HIGH POWER operation has started.
 - When the 3D AUTO button is pressed.
 - When the SILENT button is pressed.
 - When the NIGHT SETBACK button is pressed.
- Not operable while the air-conditioner is OFF.

ECO operation

Pressing the HI/ECO button initiates a soft operation with the power suppressed in order to avoid an excessive cooling or heating. The remote control displays .

The set temperature will be adjusted according to the amount of movement made by the person(s) the motion sensor has detected.

MODE: AUTO mode operation

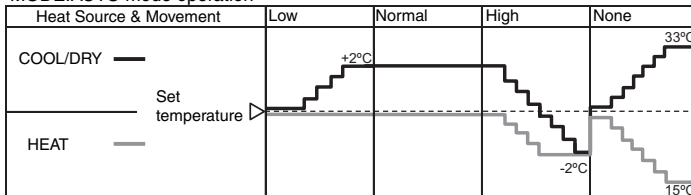

Low	When the extent of human movement is low
High	When the extent of human movement is high
None	When there is no movement of human

MODE: COOL/HEAT/DRY mode operation

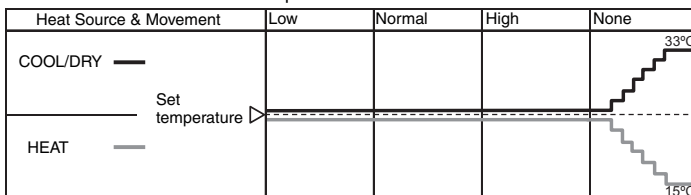

- The set temperature is automatically adjusted during ECO operation, however, the indication on the remote control display does not change.
- When the SLEEP TIMER, OFF TIMER, and ON TIMER + OFF TIMER operation are set, the motion sensor does not adjust temperatures.
- When the "None" continues for 1 hour, the FAN SPEED is set UL0.

NOTE

- It will go into ECO operation at the next time the air-conditioner runs in the following case.
 - When the air-conditioner is stopped by ON/OFF button during ECO operation.
 - When the air-conditioner is stopped in SLEEP or OFF TIMER operation during ECO operation.
 - When the operation is retrieved from SELF CLEAN or ALLERGEN CLEAR operation.
- When the following operations are set, ECO operation will be canceled.
 - When the HI/ECO button is pressed again.
 - When the operation mode is changed from DRY to FAN.
 - When the NIGHT SETBACK button is pressed.
- Not operable while the air-conditioner is OFF.

NIGHT SETBACK operation

- During the cold season, the room temperature can be maintained at a comfortable level during the absence, at night, and while the room is unattended. The air-conditioner maintains the constant temperature at about 10 °C.

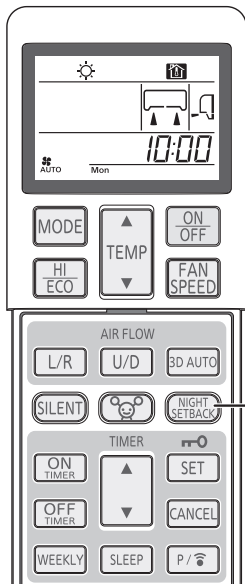

1

Press the NIGHT SETBACK button.

Every time the NIGHT SETBACK button is pressed, the display is switched in the order of:

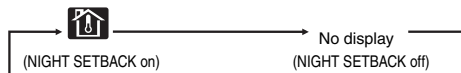

How to cancel

Press the NIGHT SETBACK button or MODE button to turn off the NIGHT SETBACK display.

NOTE

- During NIGHT SETBACK operation, the air-conditioner maintains the set temperature at about 10 °C.
- During NIGHT SETBACK operation, temperature settings cannot be made.
- Since the room temperature may change quite a bit, it is recommended that this be used when no one is in the room.
- During NIGHT SETBACK operation, HIGH POWER and ECO operations cannot be set.
- When NIGHT SETBACK operation is canceled by pressing the NIGHT SETBACK button, the operation mode is reset to the mode immediately prior to the NIGHT SETBACK operation.
- With this function, the air-conditioner maintains the room temperature at 10°C during cold seasons (heating operation).
The air-conditioner does not maintain the temperature at 10 °C during the hot/warm seasons (cooling operation).
When the room temperature is higher than 10 °C, the fan will stop or operate at a low speed.

SILENT operation

- When the SILENT operation is set, the unit operates more silently to reduce noise from the outdoor unit.
When the air-conditioner is turned off, start the operation from Step 1. When the air-conditioner is running, start from Step 2.

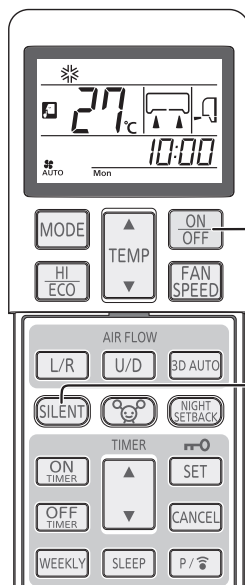

1

Press the ON/OFF button.

2

Press the SILENT button.

- When the operating mode is AUTO, COOL, HEAT or NIGHT SETBACK
Every time the SILENT button is pressed, the display is switched in the order of:

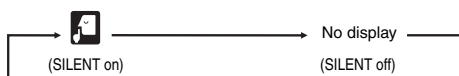

How to cancel

Press the SILENT button to turn off the SILENT display.

NOTE

- During SILENT operation, the maximum cooling and heating capacities deteriorate.
- SILENT operation will not function during DRY and FAN operation.
- In case of following operations, the air-conditioner will resume SILENT operation whenever it turns ON again.
 - When the air-conditioner is stopped by ON/OFF button during SILENT operation.
 - When the air-conditioner is stopped in SLEEP or OFF TIMER operation during SILENT operation.
 - When the operation is retrieved from SELF CLEAN or ALLERGEN CLEAR operation.
- Not operable while the air-conditioner is OFF.
- The noise level of the outdoor unit may not decrease depending on the condition.
- In case of SCM multi system, SILENT control is invalid.

MENU function

- MENU function is used for setting the Display brightness adjustment, AUTO OFF operation, SELF CLEAN operation, Fan control in heating thermo - OFF, PRESET operation, Wireless LAN connection setting, and Wireless LAN communication setting.

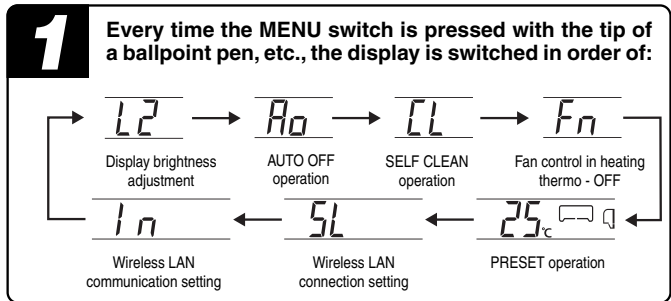
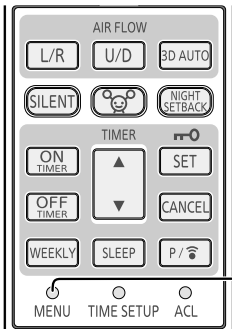

Wireless LAN connection setting

- For Wireless LAN connection setting, refer to another user's manual.

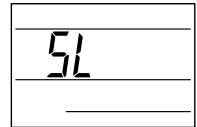

NOTE

- If the communication status is poor due to radio wave interference by an obstacle, microwave oven and so on, the operation contents may not be reflected. Check the operational status periodically.
- The operation contents of your smartphone are not reflected to the remote control display. The contents set by the remote control are reflected to the application (Smart M-Air).

Display brightness adjustment

- This function can be used when it is necessary to adjust the brightness of unit display.

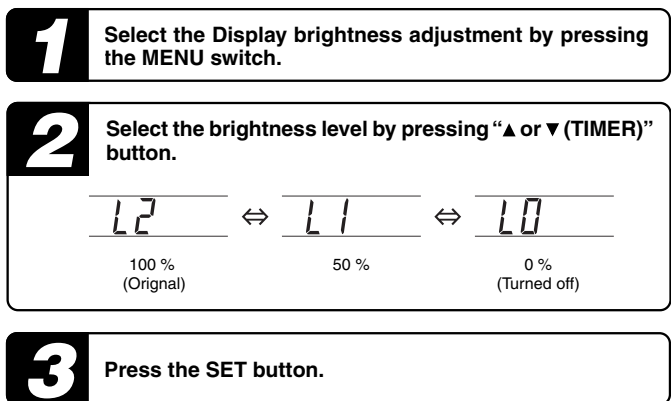
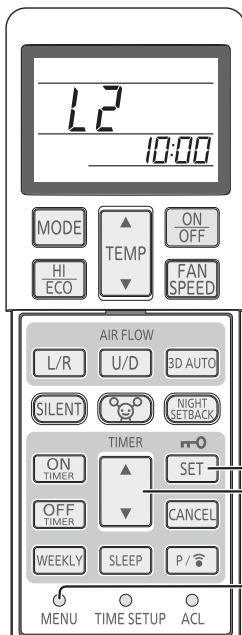

AUTO OFF operation

- In order to prevent the air-conditioner from continuing to operate although the person(s) has already left the room, the air-conditioner automatically stops approximately 1 hour (or 2 hours) after the sensor judges that there is no one in the room.

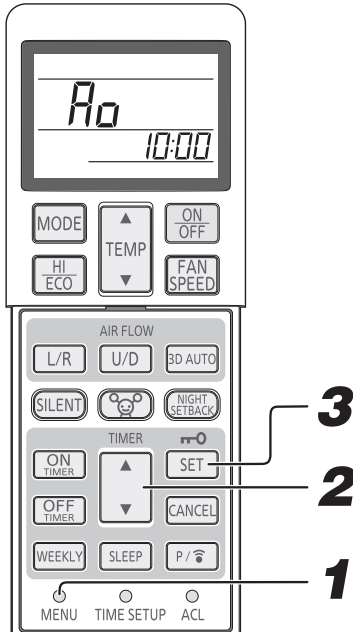

1 Select the AUTO OFF operation by pressing the MENU switch.

2 Select AUTO OFF level by pressing “▲ or ▼ (TIMER)” button.

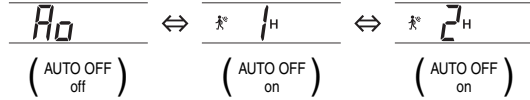

3 Press the SET button.

Settings of AUTO OFF

1 H *	Stop the operation 1 hour after the sensor judges that there is no one in the room.
2 H	Stop the operation 2 hours after the sensor judges that there is no one in the room.

* Default setting

How to cancel

In step 2, select AUTO OFF off, and press the SET button. Check that the AUTO OFF indicator has turned off.

NOTE

- Emits a warning sound, “peep, peep, peep”, and stops the operation automatically when there is no one in the room for setting time (Standby). When the motion sensor detects a person 12 hours after the operation was stopped, the operation resumes with the same settings. The operation does not resume even if a person is detected after 12 hours has elapsed. (The RUN light blinks slowly during standby.)
- It is recommended that you set the AUTO OFF function to “Off”, if people who carry out minimal movements, such as an infant or sick person, are in the room. (The motion sensor may determine that there is no one in the room, and stop operation.)
- When the SLEEP TIMER, OFF TIMER and ON TIMER + OFF TIMER operation are set, the AUTO OFF functions is disabled.
- The AUTO OFF function does not activate if the operation is started by the ON TIMER when there is no one at home.
- When 12 hours has elapsed after the operation was stopped by the AUTO OFF function, the operation does not resume even when a person walks into the room. However, the remote control display indicates operation.

SELF CLEAN operation

- SELF CLEAN operation should be run after AUTO, COOL and DRY operation to remove the moisture from inside of the indoor unit and control the growth of mold and bacteria.

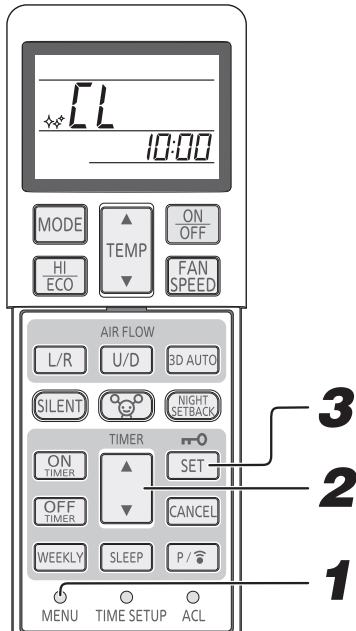

1 Select the SELF CLEAN operation by pressing the MENU switch.

2 Select SELF CLEAN on by pressing “▲ or ▼ (TIMER)” button.

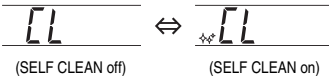

3 Press the SET button.

NOTE

- Two hours later, the air-conditioner stops SELF CLEAN operation automatically. To stop the air-conditioner immediately, press the ON/OFF button.
- SELF CLEAN operation is not operated after HEAT, FAN, OFF TIMER, SLEEP and ALLERGEN CLEAR operations have finished.
- The indoor unit fan runs for about two hours in SELF CLEAN operation.
- The RUN light illuminates during SELF CLEAN operation.

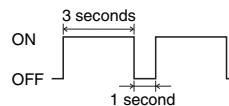

- Pressing the SLEEP button, ALLERGEN CLEAR button or NIGHT SETBACK button during SELF CLEAN operation cancels the SELF CLEAN operation and then the unit is set to SLEEP, ALLERGEN CLEAR or NIGHT SETBACK operation.
- This is not a function for removing mold, germs or grime that have already adhered to the unit.

Fan control in heating thermo - OFF

- When the room temperature reaches the set temperature during heating operation, the heating thermostat turns OFF. Fan control in heating thermo - OFF can be selected.

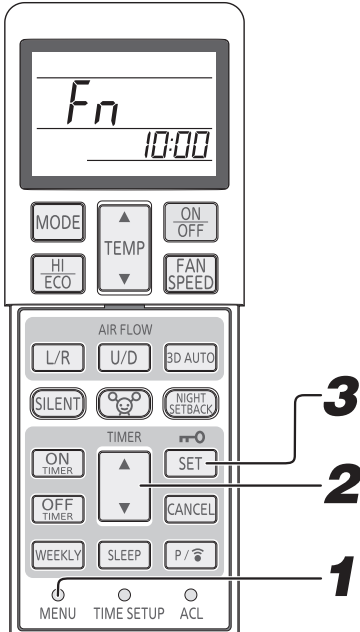

1 Select the Fan control in heating thermo - OFF by pressing the MENU switch.

2 Select the Fan control by pressing the “▲ or ▼ (TIMER)” button.

$F_n \Leftrightarrow FP \Leftrightarrow F1 \Leftrightarrow F2$
 Normal function Fireplace function Interval function Stop function

<i>F_n</i>	The air-conditioner controls the FAN SPEED automatically.
<i>FP</i>	The unit operates at the FAN SPEED set by the remote control. Heat generated from other heat sources can be circulated in the room by operating the indoor fan continuously.
<i>F1</i>	The indoor fan starts and stops the operation at regular intervals in order to avoid cold draft during heating thermo - OFF.
<i>F2</i>	The indoor fan stops. To use this function additional work is required, so consult your dealer. Otherwise, it may take time to return to heating and the heating capacity may be insufficient.

3 Press the SET button.

NOTE

- Once Fan control in heating thermo - OFF is configured, it is stored in the air-conditioner even if the power source is turned off. To change Fan control in heating thermo - OFF, set again with the remote control.
- In case of SCM multi system, Fireplace function may warm the room excessively.

PRESET operation

- This operation can save the preferred setting for future operation.

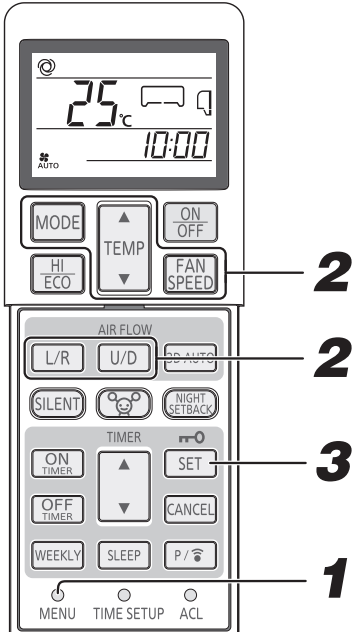

1 Select the PRESET operation by pressing the MENU switch.

2 Select preferred OPERATION MODE, TEMPERATURE, FAN SPEED and AIR FLOW direction.

3 Press the SET button.

4 When air -conditioner is operating AUTO, COOL, HEAT, DRY, FAN and NIGHT SETBACK, press MODE button 3 seconds or more. PRESET operation will start.

NOTE

- When pressing MODE button for PRESET operation during the 3D AUTO or HIGH POWER operation, it will be canceled.
- When pressing MODE button for PRESET operation during the ECO operation, it will continue.

Wireless LAN communication setting

- The wireless LAN communication can be switched between ON and OFF.
Wireless LAN communication setting can be set regardless of whether the air-conditioner is running or not.

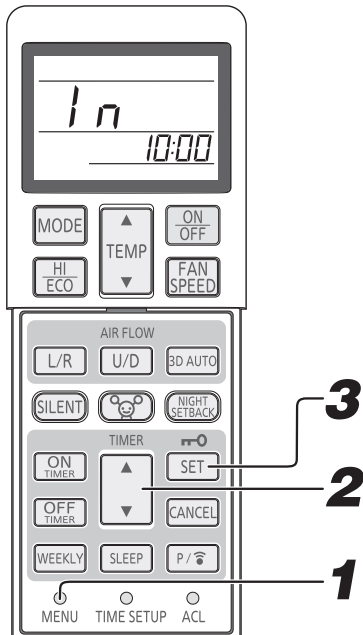

1 Select the Wireless LAN communication setting by pressing the MENU switch.

2 Select the wireless LAN communication by pressing “▲ or ▼ (TIMER)” button.



3 Press the SET button.

NOTE

- Once Wireless LAN communication setting is configured, it is stored in the air-conditioner even if the power source is turned off. To change Wireless LAN communication setting, set again with the remote control.
- If the Wireless LAN communication setting is set to OFF, the Wi-Fi function will be unavailable.

Initialization of wireless LAN interface

- If you want to reset the wireless LAN interface, it can be initialized to the status at the time of purchase.
When the wireless LAN interface is initialized, data of such as the network setting is erased.

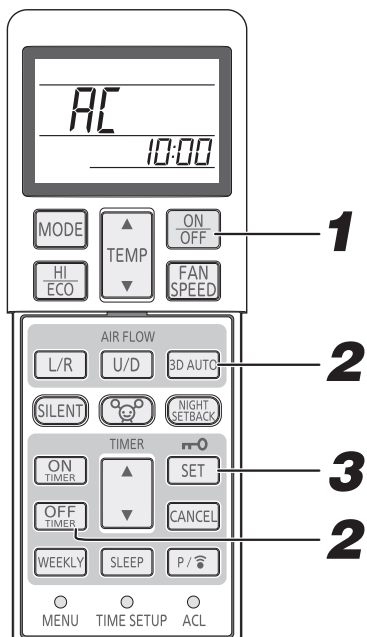

1 If the air-conditioner is running, press the ON/OFF button to stop.

The initialization of the wireless LAN interface cannot be made while the unit is running.

2 Press the OFF TIMER button and the 3D AUTO button together for 5 seconds or more.

The AC display on the remote control blinks.

3 Press the SET button for 5 seconds.

How to cancel
Press the CANCEL button.

NOTE

- Be sure to initialize the interface when the user of the air-conditioner changes or the air-conditioner is disposed of.

Maintenance

Before maintenance

Turn off the power source.

- Do not spill any liquid to the unit.
- Do not touch the aluminum fins on the heat exchanger.
- Stand firmly on a stepladder or other stable object when removing the air inlet panel and filter.

Do not use the following items:

- Hot water (40 °C or more)
It may deform or discolour the unit.
- Petrol, paint thinner, benzine or cleanser, etc. It may deform or scratch the unit.

During the operational season

Cleaning the air filter

1 Remove the air filter

Standard interval is once every two week

- Pull up the air inlet panel forward.
- Lightly hold the knobs both sides and lift a little to remove the panel forward.

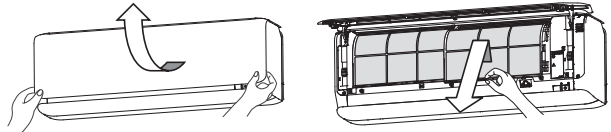

2 Cleaning

If the filter is very dirty, clean it with warm water (approx. 30 °C), and dry it thoroughly.

⚠ CAUTION

- Do not clean the filters with boiling water.
- Do not dry them over an open flame.
- Pull them out gently.

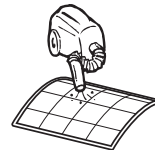

3 Reinstall the air filter

- Hold firmly the filter at both sides as shown at right and insert securely.
- Operating without the air filters will make the unit dusty, and may cause damage.

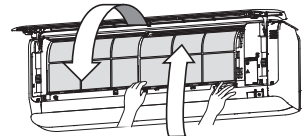

Cleaning the unit

- Wipe the unit with a soft, dry cloth, or use a vacuum cleaner.
- If the unit is very dirty, wipe it with a cloth soaked in warm water.

Cleaning the air inlet panel

- Removal, installation of air inlet panel.
- Wipe the panel with a soft, dry cloth.



⚠ CAUTION

- Do not wash the air inlet panel with water.

How to open and close the air inlet panel

Open

Place fingers at the corners on both sides of the panel and pull up the panel forward so that it will be open by about 60 degrees.

Close

Push both corners of the panel evenly and press further lightly at the center.

How to remove and install the air inlet panel

1. Basic structure

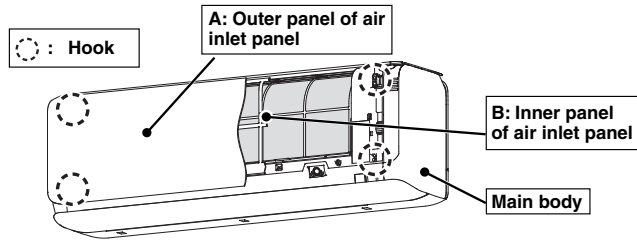

NOTE

- Air inlet panel's open/close of this unit is driven by electrical motor.
 - Improper handling by hand will cause mechanical damage and effect to open/close operation.
 - Do not close air inlet panel forcibly.
- Outer panel is to be closed automatically when power source is ON.

2. How to remove the air inlet panel

(1) Open

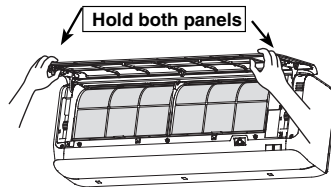
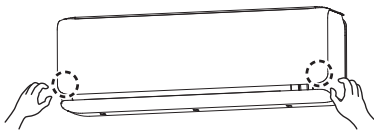

(2) Remove

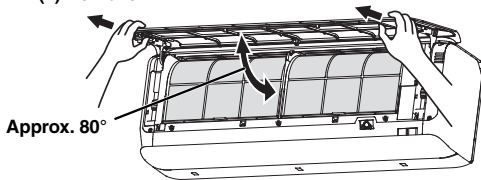

(3) Install

Insert the panel arm into the hook on the front panel from the position shown on the right (Install at the same angle as when removed.)

Hold the panel at both ends of the lower part, lower it downward slowly, and then push it slightly until it snaps into place.

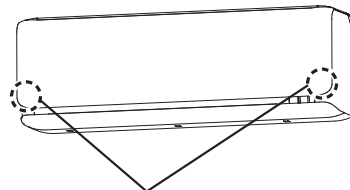

NOTE

- Cooling/heating is affected by an air filter clogged up with dust etc., and the operation noise becomes louder. It may also use extra electricity. Please clean the air filter at appropriate intervals.

At the end of the season

- 1 Perform the fan operation for 2 to 3 hours.**
Dry the inside of the unit.
- 2 Stop the unit and turn off the power source.**
The unit consumes approx. 4 W even when the unit is not operating. Turning off the power source will help saving energy consumption and cost.
- 3 Clean and reinstall the air filters.**
- 4 Clean both the indoor and outdoor units.**
- 5 Remove batteries from the remote control.**

At the beginning of the season

- 1 Ensure that the earth wiring is not snapped nor disconnected.**
- 2 Make sure that there is no corrosion or rust on the base frame of the outdoor unit.**
- 3 Make sure that there are no obstacles blocking the airflow around the air intake and outlet openings of the indoor and outdoor units.**
- 4 Turn on the power source.**
- 5 Insert batteries in the remote control.**

Installing, inspecting and replacing the air-cleaning filter

1. Open the air inlet panel and remove the air filters.  Page 34
2. Remove the allergen clear filter (Light orange) from air-conditioner and inspect the filter. Use a vacuum cleaner to remove any dust or dirt from the allergen clear filter. Replace the allergen clear filter if it cannot be cleaned or if it has been for about 1 year.
(The allergen clear filter should be replaced after about 1 year of used. However, the actual replacement period may vary depending on the conditions in which the filter is used.)

Remove the photocatalytic washable deodorizing filter (orange) from air-conditioner and inspect the filter. Periodically, remove any dust or dirt from the photocatalytic washable deodorizing filter. If the photocatalytic washable deodorizing filter is particularly dirty, it may be washed with water. However, the filter is fragile, so do not scrub it with excessive force. After washing the filter, place it in sunlight to dry. Placing the filter in sunlight restores the deodorizing effect.
3. Install the air-cleaning filter in the air-conditioner.

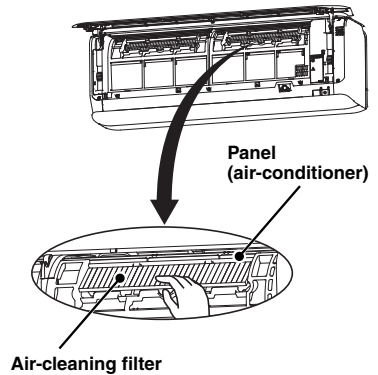

NOTE

- The allergen clear filter and the photocatalytic washable deodorizing filter may be installed on either the right or left side of the air-conditioner.
- Install the allergen clear filter with the light orange side on front side.

4. Install the air filters and close the air inlet panel.  Page 34

CAUTION

- The heat exchanger may injure your fingers.
- Stand firmly on a stepladder or other stable object when removing the air inlet panel and filters.

For replacing the air-cleaning filter, contact your dealer.

Item	Feature	Color
Allergen clear filter	The power of enzyme is used to eliminate allergy-causing allergens that accumulate on the filter.	Light orange
Photocatalytic washable deodorizing filter	Sources of odors on the filter are broken up, resulting in a deodorizing effect.	Orange

Proper installation

Suitable installation position

- Do not put any obstruction in front of the indoor unit, preventing proper ventilation and functioning.
- Do not install the unit in any of the following places:
 - Where there is a danger of leaking flammable gases.
 - Where there is substantial splashing of oil.
- Malfunctioning due to corrosion may occur if the unit is installed in a spa where sulfide gases are generated, or in a seaside resort exposed to sea breezes. Contact your dealer.
- The air-conditioner and remote control must be at least 1 meter away from a TV set or radio.
- Drain the dehumidified liquid from the indoor unit into a spot that drains well.

Pay attention to operating noises

- When you install the unit, take care to choose a place that can comfortably stand the weight of the unit and does not increase the operating noise or vibration. If vibration is transmitted through the house, fix the unit with the aid of vibration-proof pads between the unit and the fittings.
- Select a place where cold or hot air, operation noises from the indoor and outdoor units do not cause any inconvenience to your neighbours.
- Do not leave any obstacles near the outlet and inlet of the outdoor unit. This may cause malfunctioning and increased operating noise.
- If you hear an irregular noise during operation, contact your dealer.

Inspection and maintenance

Depending on operating environment, the inside of the air-conditioner may become dirty after a few year operations. This will reduce performance. In addition to normal cleaning, we would recommend inspection and maintenance. (This may lead the air-conditioner to having a longer life without any trouble.)

- Contact your dealer, or any distributor, for inspection and maintenance. (There will be a charge for this service).
- We would recommend inspection and maintenance to be carried out during the off-season.
- If the supply cord of this appliance is damaged, it must only be replaced by a repair shop appointed by the manufacturer, because special purpose tools are required.

Troubleshooting

Please carry out the following checks before making a service call.

The air-conditioner does not work at all.

- Has the power switch been turned off?
- Has the timer been set in the "ON" position?
- Is there a power failure or a blown fuse?

Poor cooling or heating

- Have you set the thermostat at a suitable temperature?
- Is the air filter clean? (Not clogged?)
- Have you left any doors or windows open?
- Is there any direct sunlight entering the room?
- Is there a heat source in the room?
- Are there too many people in the room?

If the air-conditioner does not operate properly after you have checked the left points, or if any doubt still exists after you have consulted below page and page 38, or if things happen as shown on page 39, switch off the power and contact your dealer.

Notice

Airflow

Air is not blown out when starting the HEATING operation. RUN light blinks slowly (1.5 seconds ON, 0.5 seconds OFF)	Airflow has stopped to prevent blowing out of cold air until the indoor heat exchanger has warmed up. (2 to 5 minutes)
Air is not blown out for 5 to 15 minutes or cool air is blown out for a moment at HEATING operation. RUN light blinks slowly (1.5 seconds ON, 0.5 seconds OFF)	When outdoor temperature is low and humidity is high, the unit sometimes performs defrosting automatically. Please wait. During defrosting, water or steam may release from the outdoor unit.
Air is not blown out when starting the DRY operation. (RUN light is on)	The indoor fan may stop to prevent re-evaporation of dehumidified moisture and to save energy.

■ Notice

Noise

You hear a slight gurgling sound.	This is caused by refrigerant moving within the unit.
You hear a slight cracking sound.	This is caused by heat expansion or contraction.
You hear a hissing or clicking sound.	This is caused by the operation of the refrigerant control valves or electric components.
Whistling noise is heard from the outdoor unit.	This means that the rotation speed of the compressor is increasing or decreasing.
Sometimes a “Shooooo” sound might come for a short time from the unit that is turned off.	This is the sound when operation of another indoor unit is stopped.

Operation

The timer function is canceled.	<p><u>Timer function used with Wired remote control / WF-RAC (Smartphone)</u></p> <p>The following timer functions that have be set from the wireless remote control are cancelled when the operating status of the indoor unit changes due to signals from the wired remote control or WF-RAC (Smartphone). At this time, the operational status of the indoor unit is different from the wireless remote control display. Therefore it is recommended to only set one of the timers.</p> <ul style="list-style-type: none"> • SLEEP TIMER operation • OFF TIMER operation • ON TIMER operation • SLEEP TIMER + ON TIMER operation • ON TIMER + OFF TIMER operation
The wireless remote control display and operating conditions do not match.	

Others

The unit does not restart immediately after you have stopped it. (RUN light is on)	Restart is blocked for 3 minutes after you have stopped the operation to protect the unit. The 3 minutes protection timer in the microcomputer automatically starts it up again.
Some steam releases during COOL operation.	This may occur if the room's temperature and humidity are very high. It disappears as soon as the temperature and humidity decrease. Close all windows and doors to prevent outside humidity from entering.
There is a slight smell.	Air blown out during operation may smell. This is caused by tobacco or cosmetics adhering to the unit.
After a power cut, the unit does not restart even if power has been restored.	If the auto restart function is not set, the unit will not restart automatically. Use the remote control to start the operation again.
Remote control signals are not received.	Remote control signals may not be received if the signal receiver on the air-conditioner is exposed to direct sunlight or other bright light. If so, block the sunlight or reduce the other light.
Moisture may form on the air outlet grills.	If the unit is operated for a long time in high humidity, moisture may form on the air outlet grills and start dripping.
Fan will not stop immediately after unit operation is stopped.	Indoor fan : Fan will not stop after 2 hours if set to SELF CLEAN operation. Outdoor fan : Fan will not stop about a 1 minute period in order to protect the unit.
RUN light stays on even though operation was stopped.	The RUN light illuminates during SELF CLEAN operation. Run light will turn off when SELF CLEAN operation ends.

Contact your dealer

- Turn off the power switch immediately and inform your dealer in any of the following situations:

- The fuse or switch blows continuously.
- The cable becomes extremely hot.
The covering of the cable is cracked.
- The TV, radio or other equipment starts to malfunction.
- A switch does not activate properly.
- A strange noise is heard during operation.
- When abnormalities occur, turn off the power source immediately and turn it on after 3 minutes. Restart the operation with ON/OFF button of the remote control and the abnormalities still continue.
- The RUN and TIMER lights on the unit display section blink quickly (0.5 seconds ON; 0.5 seconds OFF) or the lights do not work.

Auto restart function

- Auto restart function records the operational status of the air-conditioner immediately prior to be switched off by a power cut, and then automatically resumes operations after the power has been restored.
- The following settings will be canceled:
 - ① Timer settings
 - ② HIGH POWER operations

NOTE

- Auto restart function is set at on when the air-conditioner is shipped from the factory. Consult with your dealer if this function needs to be switched off.
- When power failure occurs, the timer setting is canceled. Once power is resumed, set the timer again.

About the multiple air-conditioners

Simultaneous Operation

- The air-conditioners cannot be in different operating modes at the same time, such as one unit being in the "Cool" mode and one unit being in the "Heat" mode.
- When conducting different operations, the air-conditioner that was operated first will be given priority, so the air-conditioner that is operated after that will conduct air blowing operation.
- When you want to give priority to the air-conditioner that was started later, either stop the air-conditioner that has priority or change the operation type of the unit operated first to match that of the unit operated second.
- When other indoor units are operating in different modes, the RUN light illuminates (at an interval of 0.5 seconds).

Automatic Operation

- When the remote control operation switch is in the AUTO mode, the air-conditioner automatically selects either COOL or HEAT mode when operation is started depending on the room temperature.
- During simultaneous operation of air-conditioners, operation modes may be automatically changed in response to the temperatures of the individual rooms; this will result in the operation of the outdoor unit being stopped. In such a case, COOL or HEAT mode should be used instead of AUTO mode. (This is only relevant when more than one air-conditioner unit is being used.)

Refrigerant (oil) recovery operation

- If the all of the indoor units are not operated at the same time for an extended period, the cooling or heating performance may temporarily decrease. This is in order to control the recovery of the refrigerant (oil) in the stopped indoor unit(s). At this time, the sound of refrigerant flowing may be heard from the stopped indoor unit(s).

Fireplace function

- Depending on operation situation, the fan speed of the unit set to Fireplace function may change automatically in heating thermo - OFF to protect the air-conditioner.

Self diagnosis function

■ We are constantly trying to do better service to our customers by installing such judges that show abnormality of each function as follows

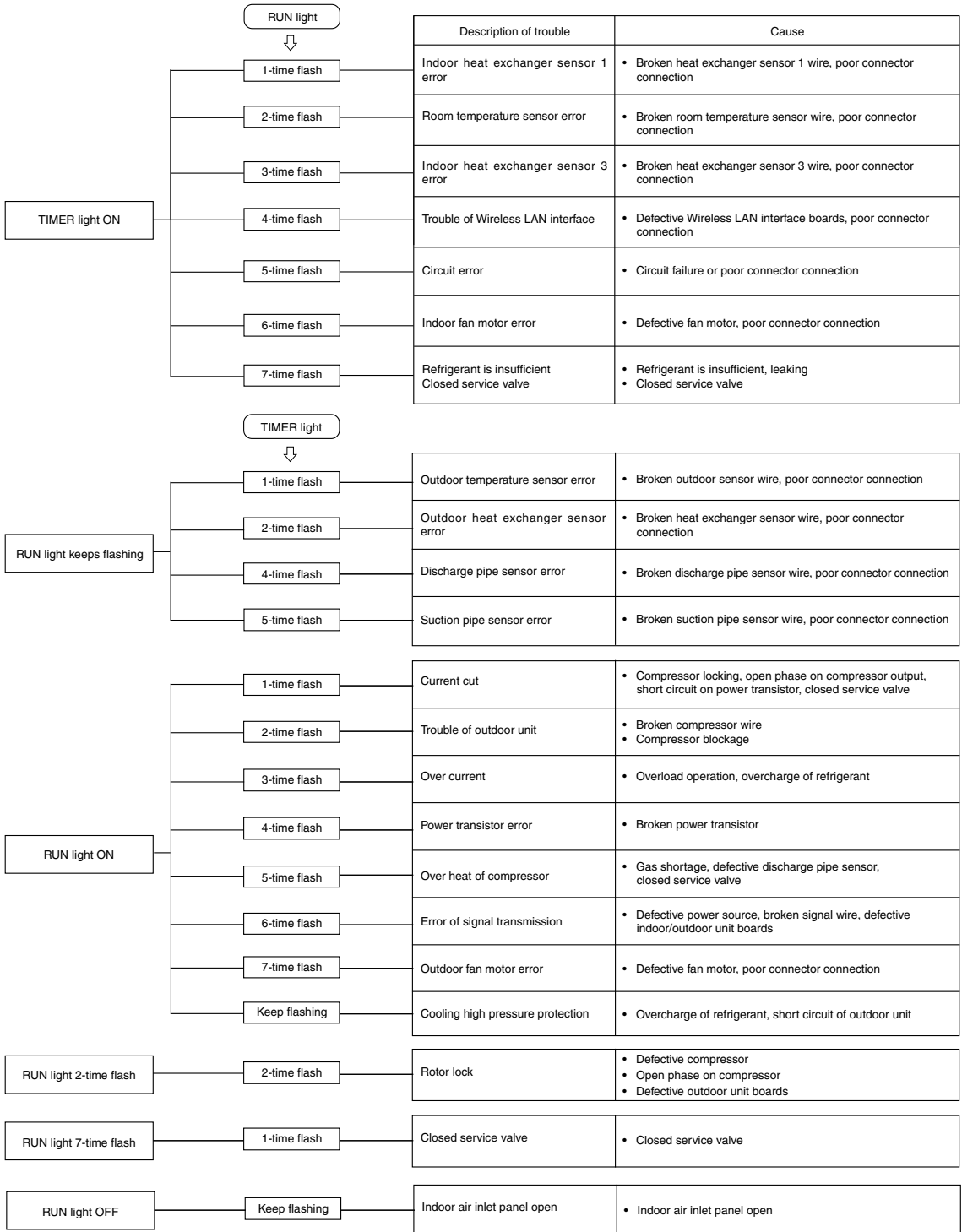

EU DECLARATION OF CONFORMITY

**MITSUBISHI HEAVY INDUSTRIES THERMAL SYSTEMS, LTD.
2-3, Marunouchi 3-chome, Chiyoda-ku, Tokyo, 100-8332, Japan**

declare under our sole responsibility that the apparatus referred to in this declaration conforms with the following directives.

**Description of apparatus: Split Type Air Conditioner
Model name:**

Conformity model list

[Indoor Unit]		[Outdoor Unit]	
Category	Model	Category	Model
SRK Series	SRK20ZSX-WF	SRK Series	SRC20ZSX-W
	SRK25ZSX-WF		SRC25ZSX-W
	SRK35ZSX-WF		SRC35ZSX-W
	SRK50ZSX-WF		SRC50ZSX-W
	SRK60ZSX-WF		SRC60ZSX-W
	SRK20ZSX-WFB		SRC20ZSX-WA
	SRK25ZSX-WFB		SRC25ZSX-WA
	SRK35ZSX-WFB		SRC35ZSX-WA
	SRK50ZSX-WFB		SRC50ZSX-WA
	SRK60ZSX-WFB		SRC60ZSX-WA
	SRK20ZSX-WFT		
	SRK25ZSX-WFT		
	SRK35ZSX-WFT		
	SRK50ZSX-WFT		
	SRK60ZSX-WFT		

Relevant EU Directives :

Machinery 2006/42/EC

Applied Standards / Regulations :

EN 60335-1

EN 60335-2-40

Authorised Representative in the EU :

MHAE SERVICES B.V.

Herikerbergweg 238, Luna Arena, 1101 CM Amsterdam, Netherlands

P.O.Box 23393 1100 DW Amsterdam, Netherlands

UK DECLARATION OF CONFORMITY

**MITSUBISHI HEAVY INDUSTRIES THERMAL SYSTEMS, LTD.
2-3, Marunouchi 3-chome, Chiyoda-ku, Tokyo, 100-8332, Japan**

declare under our sole responsibility that the apparatus referred to in this declaration conforms with the following directives.

**Description of apparatus: Split Type Air Conditioner
Model name:**

Conformity model list

[Indoor Unit]		[Outdoor Unit]	
Category	Model	Category	Model
SRK Series	SRK20ZSX-WF	SRK Series	SRC20ZSX-W
	SRK25ZSX-WF		SRC25ZSX-W
	SRK35ZSX-WF		SRC35ZSX-W
	SRK50ZSX-WF		SRC50ZSX-W
	SRK60ZSX-WF		SRC60ZSX-W
	SRK20ZSX-WFB		SRC20ZSX-WA
	SRK25ZSX-WFB		SRC25ZSX-WA
	SRK35ZSX-WFB		SRC35ZSX-WA
	SRK50ZSX-WFB		SRC50ZSX-WA
	SRK60ZSX-WFB		SRC60ZSX-WA
	SRK20ZSX-WFT		
	SRK25ZSX-WFT		
	SRK35ZSX-WFT		
	SRK50ZSX-WFT		
	SRK60ZSX-WFT		

Relevant GB Directives :

Supply of Machinery Regulations S.I. 2008/1597

Applied Standards / Regulations :

EN 60335-1

EN 60335-2-40

Authorised Representative in the GB :

MITSUBISHI HEAVY INDUSTRIES AIR-CONDITIONING EUROPE, LTD.

5 The Square, Stockley Park, Uxbridge, Middlesex, UB11 1ET, United Kingdom





MITSUBISHI HEAVY INDUSTRIES THERMAL SYSTEMS, LTD.

2-3, Marunouchi 3-chome, Chiyoda-ku, Tokyo, 100-8332, Japan
<http://www.mhi-mth.co.jp/en/>

MITSUBISHI HEAVY INDUSTRIES AIR-CONDITIONING EUROPE, LTD.

5 The Square, Stockley Park, Uxbridge, Middlesex, UB11 1ET, United Kingdom
Tel : +44-333-207-4072
Fax: +44-333-207-4089
<http://www.mhiae.com/>

MHIAE SERVICES B.V.

(Wholly-owned subsidiary of MITSUBISHI HEAVY INDUSTRIES AIR-CONDITIONING EUROPE, LTD.)
Herikerbergweg 238, Luna ArenA, 1101 CM Amsterdam, Netherlands
P.O.Box 23393 1100 DW Amsterdam, Netherlands
Tel : +31-20-406-4535
<http://www.mhiaeervices.com/>